

1/16 DIN Sized Multi-range Controller Offers Selectable Control Modes, Built-in Alarm

- Accurate to $\pm 0.5\%$ of full scale
- Multiple scale ranges allows flexibility to match application
- Field-selectable temperature ranges in $^{\circ}\text{F}$ and $^{\circ}\text{C}$
- Selectable ON/OFF and PID control with auto-tuning of proportional band
- 8-function alarm, standard
- Tamper-proof setting, faulty sensor compensation and controller diagnostics
- Easy-to-read 11 mm high LED display
- Nonvolatile memory backup
- 3-year warranty



Ordering Information

■ TEMPERATURE CONTROLLERS

Control modes		PID or ON/OFF action		
Sensor input type		Thermocouple	Platinum RTD (Pt: 100 Ω , (DIN and JIS standard types)	Interchangeable thermistor (THE types)
Output	Contact	E5CS-R1KJX-F	E5CS-R1PX-F	E5CS-R1GX-F
	Voltage	E5CS-Q1KJX-F	E5CS-Q1PX-F	E5CS-Q1GX-F

■ TEMPERATURE RANGES

Thermocouple Input Type

Input type	Type K						Type J				
	0	1	2	3	4	5	6	7	8	9	
Temperature range	0 to 200	0 to 300	0 to 400	0 to 500	0 to 600	0 to 999	0 to 999	0 to 200	0 to 300	0 to 400	0 to 500
Scale indication	$^{\circ}\text{C}$	$^{\circ}\text{C}$	$^{\circ}\text{C}/^{\circ}\text{F}$	$^{\circ}\text{C}/^{\circ}\text{F}$	$^{\circ}\text{C}/^{\circ}\text{F}$	$^{\circ}\text{C}/^{\circ}\text{F}$	$^{\circ}\text{F}$	$^{\circ}\text{C}$	$^{\circ}\text{C}$	$^{\circ}\text{C}/^{\circ}\text{F}$	$^{\circ}\text{C}/^{\circ}\text{F}$
Unit of measure	1 $^{\circ}\text{C}$ or F										

Platinum RTD Input Type

Switch setting	0	1	2	3	4	5	6	7	8
Temperature range	-50 to 50	0.0 to 50.0	-20 to 80	0.0 to 99.9	0 to 200	0 to 300	0 to 400	0 to 600	0 to 800
Scale indication	$^{\circ}\text{C}$	$^{\circ}\text{C}$	$^{\circ}\text{C}$	$^{\circ}\text{C}/^{\circ}\text{F}$	$^{\circ}\text{C}/^{\circ}\text{F}$	$^{\circ}\text{C}$	$^{\circ}\text{C}/^{\circ}\text{F}$	$^{\circ}\text{F}$	$^{\circ}\text{F}$
Unit of measure	1 $^{\circ}\text{C}$ or F								

Thermistor Input Type

Switch setting	0	1	2	3	4	5	6	7	8	9
Temperature range	-50 to 50	0 to 100	50 to 150	100 to 200	150 to 300	-50 to 100	0 to 200	100 to 300	200 to 400	300 to 600
Scale indication	$^{\circ}\text{C}$					$^{\circ}\text{F}$				
Unit of measure	1 $^{\circ}\text{C}$ or F									

■ ACCESSORIES

Description		Part number
Protective cover	Hard plastic; protects front panel against dust, dirt and water drops	Y92A-48

■ REPLACEMENT PARTS

Description		Part number
Adapter for panel mounting (supplied with each unit)		Y92F-30

Specifications

Part number		E5CS-□1KJX	E5CS-□1PX	E5CS-□1GX
Sensor input type		Thermocouple Type J (IC) and Type K (CA)	Platinum RTD (Pt: 100Ω) DIN or JIS standard	Thermistor (interchangeable type)
Supply voltage		100 to 240 VAC, 50/60 Hz; operates on 85 to 110% of rated voltage		
Power consumption		Approx. 7 VA		
Control output	Contact	Type	SPDT relay	
		Max. load	3 A, 250 VAC (resistive load)	
	Voltage	Logic load	12 VDC, 20 mA with short-circuit protection	
	Hysteresis		0.2% of full scale during ON/OFF control action	
	Response time	Output	2 seconds for output to change	
		Display	2 seconds for displayed indication to change	
Service life	Mechanical	10 million operations minimum with contact output		
	Electrical	100,000 operations minimum with contact output		
Alarm output		Type	SPST-NO relay	
		Max. load	1 A, 250 VAC (resistive load)	
		Setting range	Absolute value alarm: Same as control output setting range Others: 0 to full scale	
Setting accuracy		Set value coincides with indicated value, so no relative error exists		
Indication accuracy		±0.5% of full scale, ±1 digit max.		
Display Range		-999 to 999 (Limited to input type)		
Control modes	Type	ON/OFF and PID with automatic tuning of proportional band, switch selectable		
	Proportional band	3 to 20% (in PID mode) automatically adjusted according to the rise time of the controlled system		
	Reset time	4 minutes (in PID mode)		
	Rate time	0.4 minutes (in PID mode)		
	Proportional period	2 or 20 seconds, switch selectable		
	Sampling period	500 ms		
Materials		Plastic case		
Mounting		Fits 1/16 DIN panel cutout; includes panel mounting adapter		
Connections		Screw terminals		
Weight		170 g (6 oz.) without mounting adapter		
Enclosure ratings	Front panel	IP50, NEMA 4 with optional cover Y92A-48N		
	Rear panel	IP30		
	Terminals	IP00		
Approvals	UL	Recognized, File Number E68481		
	CSA	Certified, File Number LR59623		
Ambient temperature	Operating	-10° to 55°C (14° to 131°F)		
	Storage	-25° to 65°C (-13° to 149 °F)		
Humidity		35 to 85% RH		
Insulation resistance		20 MΩ minimum at 500 VDC		
Dielectric strength		2,000 VAC, 50/60 Hz for 1 minute between current-carrying terminals of different polarity		
Vibration	Mechanical durability	10 to 55 Hz, 0.75 mm (0.03 in) double amplitude in X, Y, and Z directions for 2 hours each		
	Malfunction durability	2 to 55 Hz, 2 G in X, Y, and Z directions for 10 minutes each		
Shock	Mechanical durability	30 m/s ² , in 6 directions, 3 times each		
	Malfunction durability	100 m/s ² , in 6 directions, 3 times each		

Dimensions

Unit: mm (inch)

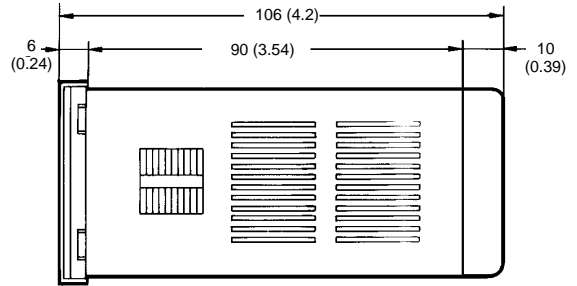
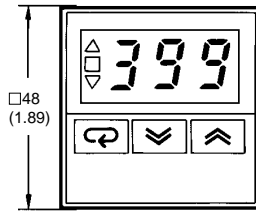
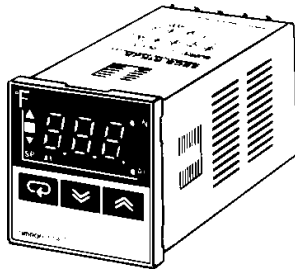

Panel Cutout

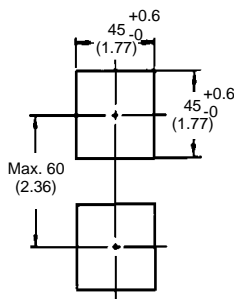

Side-by-side Mounting of Several Temperature Controllers

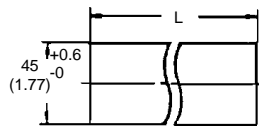

Controllers	2	3	4	5	6
L	93.5 ⁺¹ ₋₀	141.5 ⁺¹ ₋₀	189.5 ⁺¹ ₋₀	237.5 ⁺¹ ₋₀	285.5 ⁺¹ ₋₀

$L = (48 \times \text{block} - 2.5)$ ⁺¹₋₀
for tight side-by-side mounting

- Note:
1. Recommended panel thickness is 1 to 8 mm (0.04 to 0.31 in).
 2. Because mounting brackets are attached to the top and bottom of a temperature controller, tight side-by-side mounting is possible.

Nomenclature

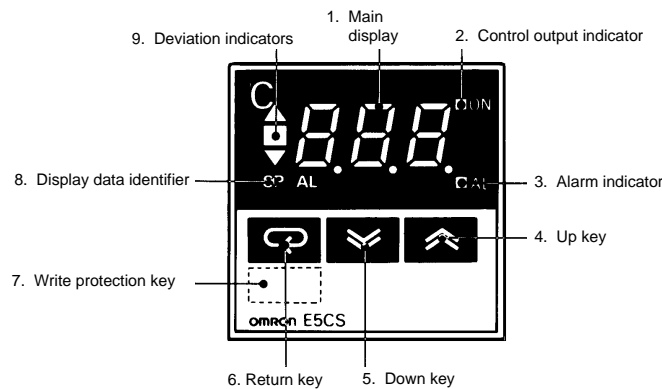

Key	Description	Key	Description
1	Main display sequentially displays the present temperature, set temperature, and an alarm value each time the return key is pressed.	7	The hidden write protection key provides protection against unauthorized to set temperatures and is used in conjunction with the internal "protection" switch. If the internal protection switch is set to ON, then to obtain Up and Down operation, the hidden key must be pressed simultaneously with the Up and Down keys. If the internal protection switch is set to OFF, changes can be made simply by pressing the Up and Down keys.
2	Control output indicator lights when the output is ON.	8	Display data identifier lights SP when the set temperature is displayed on the main display and AL when an alarm value is displayed.
3	Alarm indicator lights when the alarm output is ON.		
4	Up key increases the set temperature or alarm value when pressed. Increases the value quickly when held down.	9	Red deviation indicators light an up arrow when the present temperature is higher than the set temperature and light a down arrow when the present value is lower than the set temperature. The green block indicates the temperature deviation is within $\pm 1\%$ of the full scale.
5	Down key decreases the set temperature or alarm value when pressed. Decreases the value quickly when held down.		
6	Return key changes the value displayed on the main display each time pressed.		

Connections

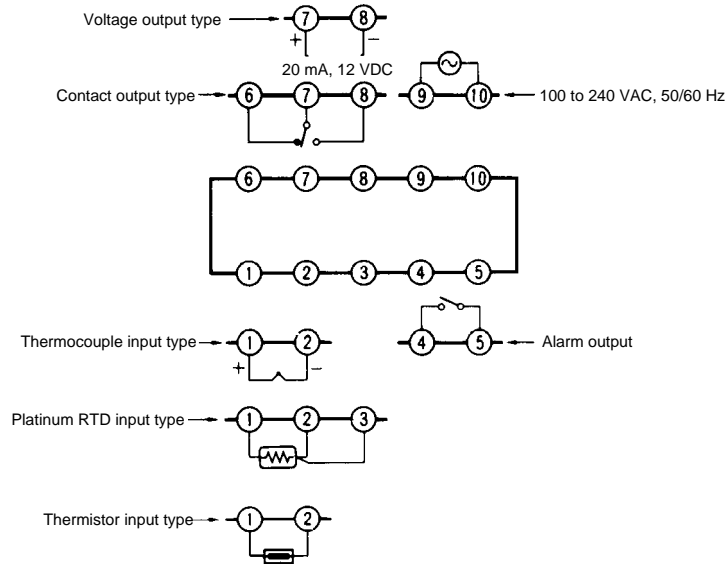

OMRON ELECTRONICS, INC.
 One East Commerce Drive
 Schaumburg, IL 60173
1-800-55-OMRON

OMRON CANADA, INC.
 885 Milner Avenue
 Scarborough, Ontario M1B 5V8
416-286-6465