User's Manual



FDC-PXR
Process / Temperature Profiler

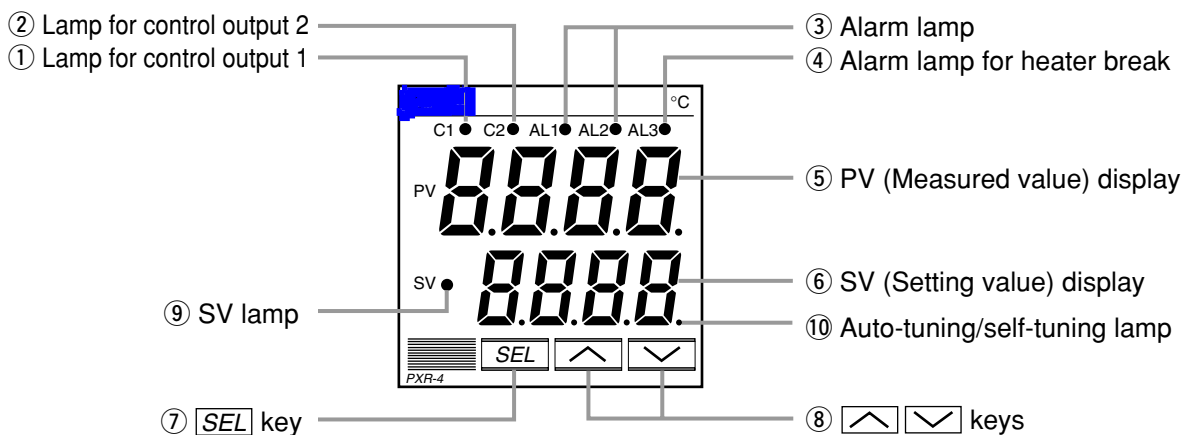



Table of Contents

1 Part Names and Functions	4
2 Operations	5
2-1 Parameter list	5
2-2 Basic operations	9
2-3 Parameter functions and method of settings	10
Standby setting	11
Ramp-soak control	12
Canceling the alarm latch	13
Auto-tuning function	14
Displaying ON-delay alarm or the remaining time of timers	15
Setting alarm 1 and 2	16
Upper limit of alarm 1 and 2	16
Lower limit of alarm 1 and 2	16
Key lock	17
Proportional band	18
Integral time	19
Derivative time	20
Hysteresis range for ON/OFF control	21
Cooling-side proportional band coefficient	22
Cooling-side proportional band shift (Dead band/Overlap band)	23
Output offset value	24
Anti-reset windup	24
Control algorithm	25
PV (Measured value) stable range	29
HYS (Hysteresis) mode at ON/OFF control	30
Cycle time of control output 1	31
Cycle time of control output 2 (Cooling-side)	32
Input signal code	33
Setting the measuring range (Input range)	34
Selection °C / °F	34
Decimal point position	36
PV (Measured value) offset	37
SV (Setting value) offset	38
Time constant of input filter	39
Alarm types	40
Selecting ramp-soak execute type	43
Ramp-soak status display	44
1st to 8th target SV	44
1st to 8th ramp segment time	44
1st to 8th soak segment time	44
Ramp-soak modes	44
Specifying control action and output direction at input burn-out	47
SV (Setting value) lower limiter	48
SV (Setting value) upper limiter	48
The time of ON-delay alarm or timer function	49

1 Part Names and Functions

This chapter explains the part names and functions on the face panel. The face panel has the PV and SV displays, the status indicating lamp, and the setting keys, etc. Those functions are explained below. Please read and understand them before using the PXR. For details about the setting of parameters, see Chapter 2.



- ① Lamp for control output 1
Lights up while control output 1 stays ON.
- ② Lamp for control output 2
Lights up while control output 2 stays ON.
- ③ Alarm lamp
Lights up when an error occurs. While the lamp lights up, the alarm output stays ON.
- ④ Alarm lamp for heater break
Lights up when the heater is broken. While the lamp lights up, the alarm output for heater break stays ON.
- ⑤ PV (Measured value) display
Displays the PV. When setting a parameter, its name appears.
- ⑥ SV (Setting value) display
Displays the SV. When setting a parameter, its value appears.
- ⑦ **SEL** key
Used to select a parameter block and a parameter, and register a set value.
- ⑧   keys
Used to change the SV, call parameters, and change parameter values.
- ⑨ SV lamp
Lights up while the SV is displayed in the SV display. When parameters and data are displayed, the SV lamp goes out.
- ⑩ Auto-tuning/self-tuning lamp
Flashes under an auto-tuning or self-tuning operation.

2 Operations

This chapter explains how to set the SV (Setting value) and the parameters for the PXR.

2-1 Parameter list

Parameters for the PXR are classified under three blocks according to the frequency of use. The parameters of the second and third blocks are used at initialization or when they are of absolute necessity.

Parameters of the first block

Parameter display symbol	Parameter name	Description	Setting range and factory default setting (*)	User's set value	Parameter mask DSP	Reference page
<i>Srby</i>	Standby setting	Switches between RUN and Standby for control.	oN: Control standby (Output: OFF, Alarm: OFF) oFF: Control RUN*		dSP1-1	11
<i>PrsoG</i>	Ramp-soak control	Switches between Start, Stop, and Hold for ramp-soak control	oFF: Stop* rUn: Start HLd: Hold		dSP1-2	12
<i>LACh</i>	Alarm latch cancel	Cancels the alarm latch.	0: Keeps the alarm latch.* 1: Opens up the alarm latch.		dSP1-4	13
<i>AT</i>	Auto-tuning	Used for setting the constants for P , I , and d by auto-tuning.	0: OFF (Resets the auto-tuning or does not use it.)* 1: ON (Performs the auto-tuning in the SV standard type.) 2: ON (Performs the auto-tuning in low PV type (SV value-10%FS).)		dSP1-8	14
<i>Tn-1</i>	Timer 1 display	Displays the remaining time of timer 1.	- (Unit: seconds)		dSP1-16	15
<i>Tn-2</i>	Timer 2 display	Displays the remaining time of timer 2.	- (Unit: seconds)		dSP1-32	15
<i>AL1</i>	Set value of alarm 1	Sets the value at which alarm 1 is detected.	<i>AL1</i> is displayed when alarm type 1 is 0 to 15, or 32 to 34, and <i>AL1-H</i> or <i>AL1-L</i> is displayed when alarm type 1 is 16 to 31.		dSP1-128	16 *
<i>AL1-L</i>	Lower limit value of alarm 1	Sets the lower limit value at which alarm 1 is detected.			dSP2-1	16 *
<i>AL1-H</i>	Upper limit value of alarm 1	Sets the upper limit value at which alarm 1 is detected.			dSP2-2	16 *
<i>AL2</i>	Set value of alarm 2	Sets the value during which alarm 2 is detected.	<i>AL2</i> is displayed when alarm type 2 is 0 to 15 or 32 to 34, and <i>AL2-H</i> or <i>AL2-L</i> is displayed when alarm type 2 is 16 to 31.		dSP2-4	16 *
<i>AL2-L</i>	Lower limit value of alarm 2	Sets the lower limit value at which alarm 2 is detected.			dSP2-8	16 *
<i>AL2-H</i>	Upper limit value of alarm 2	Sets the upper limit value at which alarm 2 is detected.			dSP2-16	16 *
<i>LoL</i>	Key lock	Specifies whether or not to allow the change of parameters.	0: All settings are changeable both from the face panel and via communication.* 1: All settings are unchangeable from the face panel, but changeable via communication. 2: Only the SV is changeable from the face panel, and all settings are changeable via communication. 3: All settings are changeable from the face panel, but unchangeable via communication. 4: All settings are unchangeable from the face panel or via communication. 5: Only the SV is changeable from the face panel, but all settings are unchangeable via communication.		dSP3-1	17

Note: The parameters for which * is marked with the page number in Reference page are related to Remedies of "4" on page 68.

Parameters of the second block

Note: The parameters for which * is marked with the page number in Reference page are related to Remedies of "4" on page 68.

Parameter display symbol	Parameter name	Description	Setting range and factory default setting (*)	User's set value	Parameter mask DSP	Reference page
P	Proportional band	Set P to 0.0 to select the ON/OFF control (Two-position control).	0.0 to 999.9% (*: 5.0)		dSP3-2	18
I	Integral time		0 to 3200 seconds (*: 240)		dSP3-4	19
D	Derivative time		0.0 to 999.9 seconds (*: 60.0)		dSP3-8	20
HYS	Hysteresis range for ON/OFF control	Sets the hysteresis for ON/OFF control.	0 to 50%FS (*: equivalent of 1.0°C)		dSP3-16	21 *
CoOL	Cooling-side proportional band coefficient		0.0 to 100.0 (*: 1.0)		dSP3-32	22
db	Cooling-side proportional band shift		-50.0 to +50.0 (*: 0.0)		dSP3-64	23
bAL	Output convergence value		-100 to 100% (*: single 0.0, dual 50.0)		dSP3-128	24
Ar	Anti-reset windup		0 to 100%FS (*: 100%FS)		dSP4-1	24 *
CrL	Control algorithm	Selects the control algorithm.	PID: Runs normal PID control.* FUZY: Runs PID control with fuzzy logic. SELF: Runs PID control with self-running.		dSP4-2	25
SLFb	PV (Measured value) stable range	Sets the PV stable range for the self-tuning operation.	0 to 100%FS (*: 2%FS)		dSP4-4	29 *
onof	Setting HYS (Hysteresis) mode	Selects the hysteresis operation at ON/OFF control.	oFF: Starts the two-position control at the values of SV+HYS/2 and SV-HYS/2. on: Starts the two-position control at the values of SV and SV+HYS, or SV and SV-HYS.		dSP4-8	30
CC	Cycle time of control output 1	Not shown at 4-20mA DC output	RLY, SSR: 1 to 150 seconds (*: Contact output = 30, SSR/SSC-driven output = 2)		dSP4-16	31
CC2	Cycle time of control output 2 (cooling-side)		1 to 150 seconds (*: 30)		dSP4-32	32
P-n2	Input signal code	Set this parameter when changing the types of temperature sensors.	1 to 16 (*: specified by customer while ordering) Note 1		dSP4-64	33
P-SL	Lower limit of measuring range		-1999 to 9999 (*: specified by customer while ordering) Note 1		dSP4-128	34
P-SU	Upper limit of measuring range		-1999 to 9999 (*: specified by customer while ordering) Note 1		dSP5-1	34
P-dP	Setting the decimal point position		0 to 2 (*: specified by customer while ordering) Note 1		dSP5-2	36
P-F	°C / °F selection		°C / °F		dSP5-4	34
PUDF	PV (Measured value) offset		-10 to 10%FS (*: 0)		dSP5-8	37 *
SUDF	SV (Setting value) offset		-50 to 50%FS (*: 0)		dSP5-16	38 *
P-dF	Time constant of input filter		0.0 to 900.0 seconds (*: 5.0)		dSP5-32	39
ALN1	Alarm type 1	Sets the types of alarm operations.	0 to 34 (*: 0/5)		dSP5-64	40
ALN2	Alarm type 2	Sets the types of alarm operations.	0 to 34 (*: 0/9)		dSP5-128	40
SRAR	Status display of ramp-soak		- (*: OFF)		dSP6-2	44
PRn	Selecting ramp-soak execute type	Selects ramp-soak patterns.	1: Performs 1st to 4th segments.* 2: Performs 5th to 8th segments. 3: Performs 1st to 8th segments.		dSP6-4	43
SU-1	1st target value /Switching-SV value	Sets the 1st target SV of ramp-soak operation. / Selected at switching-SV function for DII	Within the SV limit. (*: 0%FS)		dSP6-8	44 *
FR1r	First ramp segment time	Sets the 1st ramp segment time.	0 to 99h59m (*: 0.00)		dSP6-16	44

Note: The parameters for which * is marked with the page number in Reference page are related to Remedies of “4” on page 68.

Parameter display symbol	Parameter name	Description	Setting range and factory default setting (*)	User's set value	Parameter mask DSP	Reference page
<i>r n 15</i>	1st soak segment time	Sets the 1st soak segment time.	0 to 99h59m (*: 0.00)		dSP6-32	44
<i>50-2</i>	2nd target SV	Sets the 2nd target SV of ramp-soak operation.	Within the SV limit. (*: 0%FS)		dSP6-64	44*
<i>r n 2r</i>	2nd ramp segment time	Sets the 2nd ramp segment time.	0 to 99h59m (*: 0.00)		dSP6-128	44
<i>r n 25</i>	2nd soak segment time	Sets the 2nd soak segment time.	0 to 99h59m (*: 0.00)		dSP7-1	44
<i>50-3</i>	3rd target SV	Sets the 3rd target SV of ramp-soak operation.	Within the SV limit. (*: 0%FS)		dSP7-2	44*
<i>r n 3r</i>	3rd ramp segment time	Sets the 3rd ramp segment time.	0 to 99h59m (*: 0.00)		dSP7-4	44
<i>r n 35</i>	3rd soak segment time	Sets the 3rd soak segment time.	0 to 99h59m (*: 0.00)		dSP7-8	44
<i>50-4</i>	4th target SV	Sets the 4th target SV of ramp-soak operation.	Within the SV limit. (*: 0%FS)		dSP7-16	44*
<i>r n 4r</i>	4th ramp segment time	Sets the 4th ramp segment time.	0 to 99h59m (*: 0.00)		dSP7-32	44
<i>r n 45</i>	4th soak segment time	Sets the 4th soak segment time.	0 to 99h59m (*: 0.00)		dSP7-64	44
<i>50-5</i>	5th target SV	Sets the 5th target SV of ramp-soak operation.	Within the SV limit. (*: 0%FS)		dSP7-128	44*
<i>r n 5r</i>	5th ramp segment time	Sets the 5th ramp segment time.	0 to 99h59m (*: 0.00)		dSP8-1	44
<i>r n 55</i>	5th soak segment time	Sets the 5th soak segment time.	0 to 99h59m (*: 0.00)		dSP8-2	44
<i>50-6</i>	6th target SV	Sets the 6th target SV of ramp-soak operation.	Within the SV limit. (*: 0%FS)		dSP8-4	44*
<i>r n 6r</i>	6th ramp segment time	Sets the 6th ramp segment time.	0 to 99h59m (*: 0.00)		dSP8-8	44
<i>r n 65</i>	6th soak segment time	Sets the 6th soak segment time.	0 to 99h59m (*: 0.00)		dSP8-16	44
<i>50-7</i>	7th target SV	Sets the 7th target SV of ramp-soak operation.	Within the SV limit. (*: 0%FS)		dSP8-32	44*
<i>r n 7r</i>	7th ramp segment time	Sets the 7th ramp segment time.	0 to 99h59m (*: 0.00)		dSP8-64	44
<i>r n 75</i>	7th soak segment time	Sets the 7th soak segment time.	0 to 99h59m (*: 0.00)		dSP8-128	44
<i>50-8</i>	8th target SV	Sets the 8th target SV of ramp-soak operation.	Within the SV limit. (*: 0%FS)		dSP9-1	44*
<i>r n 8r</i>	8th ramp segment time	Sets the 8th ramp segment time.	0 to 99h59m (*: 0.00)		dSP9-2	44
<i>r n 85</i>	8th soak segment time	Sets the 8th soak segment time.	0 to 99h59m (*: 0.00)		dSP9-4	44
<i>n od</i>	Ramp-soak mode	Selects the power-on start, repeat, and standby functions for ramp-soak operations.	0 to 15 (*: 0)		dSP9-8	44

Note 1: When a customer does not specify the settings while ordering, the following settings are selected as factory defaults.

Thermocouple input: Thermocouple K Measured range: 0 to 400°C
Resistance bulb input: Measured range: 0 to 150°C
Voltage/Current input: Scaling: 0 to 100%

Parameters of the third block

Note: The parameters for which * is marked with the page number in Reference page are related to Remedies of “4” on page 68.

Parameter display symbol	Parameter name	Description	Setting range and factory default setting (*)	User's set value	Parameter mask DSP	Reference page
P-n1	Control action	Specifies control action and output at the input burn-out.	0 to 19 (*: specified by customer while ordering) Note 2		dSP9-16	47
SV-L	SV (Setting value) lower limiter	Sets the lower limit of the SV.	0 to 100%FS (*: 0%FS)		dSP9-32	48*
SV-H	SV (Setting value) upper limiter	Sets the upper limit of the SV.	0 to 100%FS (*: 100%FS)		dSP9-64	48*
dLY1	Delay time 1	Delay time or timer value for alarm 1 relay.	0 to 9999 seconds (*: 0)		dSP9-128	49
dLY2	Delay time 2	Delay time or timer value for alarm 2 relay.	0 to 9999 seconds (*: 0)		dSP10-1	49
CT	Current trans display	Displays the current detector input value for HB alarm.	-		dSP10-4	51
Hb	HB (Set value of heater break alarm) setting	Sets the operation value that detects the heater break.	0 to 50.0A (Setting to 0.0A turns off the HB alarm.) (*: 0.0)		dSP10-8	51
A1hY	Alarm 1 hysteresis	Sets the hysteresis range of ON and OFF of alarm 1.	0 to 50%FS (*: 1)		dSP10-16	53*
A2hY	Alarm 2 hysteresis	Sets the hysteresis range of ON and OFF of alarm 2.	0 to 50%FS (*: 1)		dSP10-32	53*
A1oP	Alarm 1 options	Sets the optional functions of alarms 1 and 2.	000 to 111 (*: 000)		dSP10-128	54
A2oP	Alarm 2 options	<div style="border: 1px solid black; padding: 2px; width: fit-content;">0000</div> <ul style="list-style-type: none"> └ Alarm latch (1: use, 0: not use) └ Alarm of error status (1: use, 0: not use) └ De-energized output (1: use, 0: not use) 	000 to 111 (*: 000)		dSP11-1	54
PLC1	Lower limit for output 1	Sets the lower limit for output 1.	-3.0 to 103.0% (*: -3.0)		dSP11-4	56
PHC1	Upper limit for output 1	Sets the upper limit for output 1.	-3.0 to 103.0% (*: 103.0)		dSP11-8	56
PLC2	Lower limit for output 2	Sets the lower limit for output 2.	-3.0 to 103.0% (*: -3.0)		dSP11-16	56
PHC2	Upper limit for output 2	Sets the upper limit for output 2.	-3.0 to 103.0% (*: 103.0)		dSP11-32	56
PCUR	Output limit types	Sets the limit types of outputs 1 and 2 (breaking the limit, or maintained within the limit).	0 to 15 (*: 0)		dSP11-64	57
oUF1	Output value (MV) display	Displays the value of output 1.	-		dSP11-128	58
oUF2	Output value (MV) display	Displays the value of output 2.	-		dSP12-1	58
RCJ	RCJ (Cold junction compensation) setting	Sets the cold junction compensation function to ON/OFF.	ON: Performs the RCJ (Cold junction compensation).* OFF: Does not perform the RCJ (Cold junction compensation).		dSP12-2	59
GRAn	PV gradient		0.001 to 2.000 (*: 1.000)		dSP12-4	
AdU0	User-definable zero adjustment	Shifts the zero point of input value.	-50 to 50%FS (*: 0)		dSP12-8	60*
AdU5	User-definable span adjustment	Shifts the span of input value.	-50 to 50%FS (*: 0)		dSP12-16	60*
dI-1	DI1 (Digital input 1) operation	Sets the DI1 operations.	0 to 12 (*: 0=OFF)		dSP12-32	61
StNo	Station No.	Sets the station No. for communication.	0 to 255 (Setting to 0 does not start the communications function.) (*: 1)		dSP12-128	64
CoP	Parity setting	Sets the parity for communication. (The baud rate is fixed at 9600bps.	0: Odd parity* 1: Even parity 2: No parity		dSP13-1	65
PYP	Input type for PYP (Color Touch-Operation Unit)	Sets the input type for communicating with PYP.	0 to 255 (*: 34)		dSP13-2	66
dSP1 to dSP9 dP10 to dP13	Parameter mask	Sets whether or not to display each parameter.	0 to 255 (*: specified by customer while ordering)		-	67

Note 2: The following settings are selected as factory defaults depending on the model you order.

Seventh digit = Y model: 0

Seventh digit = A model: 4

2-2 Basic operations

Just after power-on:

The display below appears just after power-on.

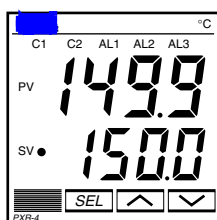

How to switch parameters:

The figure below shows the basic operations for the PXR.

If it has not been used for 30 seconds, the display returns to the one just after power-on (PV/SV displayed).

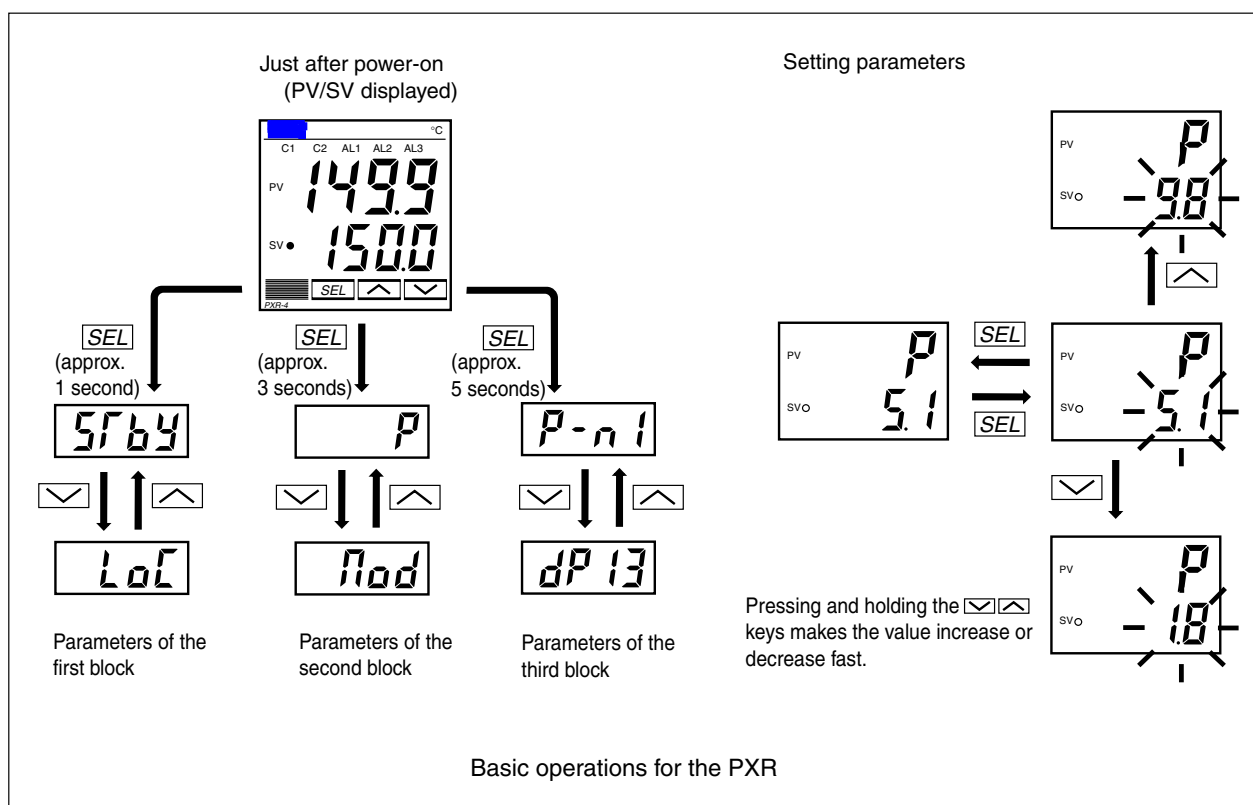

How to set values:

key: One press increases the value by 1.

Press and hold this key to increase the value fast.

key: One press decreases the value by 1.

Press and hold this key to decrease the value fast.

How to register the set data:

By pressing the **SEL** key, the displayed values are registered.

Note that the SV (SV0) will be registered in 3 seconds without any operation.

2-3 Parameter functions and method of settings

Method of setting the SV (Setting value)



[Description]

- The SV is a target value for control.
- Any SV that is outside of the range set in the parameters of $SV-L$ (lower limit) and $SV-H$ (upper limit) of the third block cannot be set. (See page 48.)

Related parameters: $SV-L$ (page 48)

$SV-H$ (page 48)

[Setting example] Changing the SV from 250°C to 1195°C













Display	Operating procedure
	<ol style="list-style-type: none">1. Press the  or  keys to display <i>1195</i>.2. <i>1195</i> will be registered in the SV (SV0) in three seconds. After that, the controller will operate with the SV being 1195.

Standby setting (Settings: oFF/on)

[Description]

- This parameter switches the control between RUN and Standby.
- During standby, the control output and the alarm output stay OFF, like the standby for ramp-soak operation.
- While the alarm with a hold is selected, the hold function takes effect after changing the Standby setting from ON to OFF.
- **5rby** is displayed during the standby for ramp-soak operations or the controller changes to the standby state in case of the occurrence of errors.
- The other operations are the same as those of the ramp-soak standby.
- The setting of ON/OFF for standby is saved after power-off.
- When the standby is set to ON during the auto-tuning, self-tuning, and ramp-soak operations, those operations will stop. (The PID constant will not be renewed.) Even through it is set to OFF later, the auto-tuning, self-tuning, and ramp-soak operations will not be re-started.
- During standby, the ON-delay timer is reset. When returning to RUN from the standby state, the timer will start from the beginning.

[Setting example] Starting the control

Display	Operating procedure
 	<ol style="list-style-type: none"> 1. Press and hold the SEL key for one second. 5rby will be displayed. 2. Press the SEL key once. The current setting (oFF) flashes on the SV display. 3. Press the  or  keys to display on. 4. Press the SEL key once. The standby state for control is selected. (control output and all the alarm outputs: OFF) 5. If you want to display the operation status, press and hold the SEL key for two seconds. The value on the SV display will flash, indicating the standby status.
 	
 	
 	
 	

Prog Ramp-soak control (Settings: oFF/rUn/hLd) (Option)

[Description]



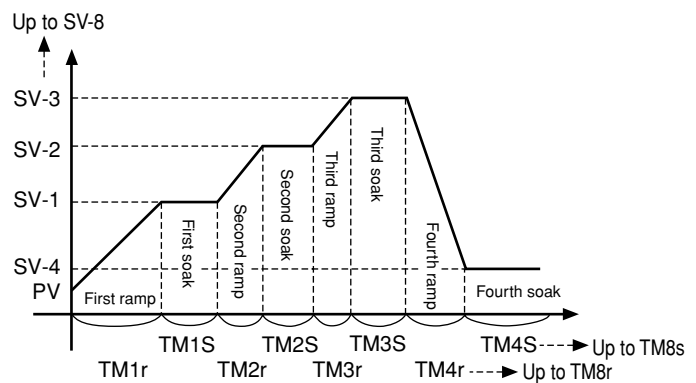



- This function automatically changes the SV (Setting value) according to the program pattern set in advance as shown in the right line graph. Up to eight pairs of ramp-soak operation can be programmed.
- The first ramp starts at the PV (Measured value) that is the one just before running the program.
- The program can also automatically run at power-on (Power-on starting function). Refer to the parameter of *Pod* (page 44).



Related parameters: *SrAr* (page 44)
Sv-1 to *Sv-8* (page 44)
rNr to *rNs* (page 44)
rN1S to *rN8S* (page 44)
Pod (page 44)
Pfn (page 43)

Ramp: the section in which the SV changes toward the target value.
 Soak: the section in which the SV is the target value, and remains unchanged.

[Setting example] Starting the ramp-soak operation

Display	Operating procedure
      	<ol style="list-style-type: none"> 1. Press and hold the SEL key for one second. <i>5rby</i> will be displayed on the PV display. 2. Press the <input checked="" type="checkbox"/> key to display <i>Prog</i> 3. Press the SEL key once. The current setting (<i>oFF</i>) flashes on the SV display. 4. Press the <input checked="" type="checkbox"/> or <input checked="" type="checkbox"/> keys to display <i>rUn</i>. 5. Press the SEL key once. Then, the program will start according to the ramp-soak pattern that is set in advance. 6. If you want to display the operation status, press and hold the SEL key for two seconds.

LACH Canceling the alarm latch (Settings: 0/1) (Option)











[Description]

- This parameter cancels the alarm latch when it is latching.

Related parameters:

R1oP to *R2oP* (page 54)

[Setting example] Canceling the alarm latch

Display	Operating procedure
	<ol style="list-style-type: none"> Press and hold the SEL key for one second. <i>Srby</i> will be displayed on the PV display. Press the  key to display LACH. Press the SEL key once. The current setting (<i>0</i>) flashes on the SV display. Press the  or  keys to display <i>1</i>. Press the SEL key once. <i>1</i> will stop flashing and will change to <i>0</i> in a few seconds. If you want to display the operation status, press and hold the SEL key for two seconds.
	
	
	
	
	
	

AT Auto-tuning function (Settings: 0/1/2)

[Description]

[Note]

- If the controller is powered off during auto-tuning, this makes the auto-tuning ineffective with each parameter of P , \bar{z} , and d unchanged. To start the auto-tuning operation, set AT to "1" or "2" again.
- To suspend the auto-tuning, set AT to "0". This makes the auto-tuning cancel with each parameter of P , \bar{z} , and d unchanged.
 - Once the parameters of P , \bar{z} , and d are set automatically by the auto-tuning, those parameters are stored in the controller even after it is powered off. Therefore, it is not necessary to execute the auto-tuning again.
 - By setting AT to "1" or "2", the auto-tuning operation starts, and at the end of the tuning, t will be displayed automatically to AT .
 - After the auto-tuning operation, the controller starts to operate with P , \bar{z} , and d values set automatically.
 - A decimal point at the right end of the SV display flashes during auto-tuning.

- There are two codes for AT:
 - Setting code [1]: SV standard type
Performs the auto-tuning based on the SV.
 - Setting code [2]: Low PV type
Performs the auto-tuning based on the SV-10%FS.









[Note]

- Since ON/OFF control is performed during auto-tuning, overshoot against the SV may occur. To reduce the overshoot, execute the auto-tuning operation with the setting code [2] (Low PV) selected.
- The auto-tuning can be executed both just after power-on and in a control or stable status.

Related parameters:

- P (page 18)
- \bar{z} (page 19)
- d (page 20)
- Ar (page 24)
- $CoOL$ (page 22)

[Setting example] Setting the auto-tuning operation to 1

Display	Operating procedure
       	<ol style="list-style-type: none"> Press and hold the [SEL] key for one second. $5rb4$ will be displayed on the PV display. Press the [V] key to display AT. Press the [SEL] key once. The current setting (0) flashes on the SV display. Press the [^] or [v] keys to display 1. Press the [SEL] key once. 1 will stop flashing and the auto-tuning will start. During auto-tuning, a decimal point at the right end of the SV display flashes. When the auto-tuning finishes properly, a decimal point stops flashing, and the set values of P, \bar{z}, and d parameters change. When the auto-tuning finishes abnormally, a decimal point stops flashing, but the set values of P, \bar{z}, and d parameters remain unchanged. If you want to display the operation status, press and hold the [SEL] key for two seconds.

FN-1, FN-2 Displaying ON-delay alarm or the remaining time of timers (unit: seconds) (Option)

[Description]

- These parameters display the remaining time of Timers 1 and 2.
- The remaining time of the ON/OFF-delay timer is counted down. When the counter shows 0, the alarm relay is closed.
- During count-down, if the PV changes to the value of the temperature at which the alarm is set to OFF, or if “DI” for the timer is set to OFF, the counter is reset, and the alarm relay is opened.

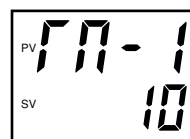

- FN-1 display parameter



← Remaining time (seconds)

[Setting example] Displaying ON-delay alarm or the remaining time of timers

Display	Operating procedure
 	1. Press and hold the [SEL] key for one second. <i>SfbY</i> will be displayed.
	2. Press the key to display <i>FN-1</i> . The remaining time of timer 1 will be displayed.
	3. Press the or keys to display the remaining timer of <i>FN-1</i> and <i>FN-2</i> .
	4. If you want to display the operation status, press and hold the [SEL] key for two seconds.

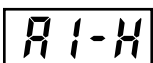
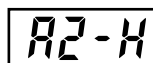
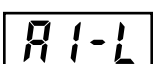
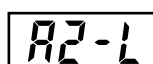
		Setting alarm 1 and 2	} (Setting range: Absolute value alarm: 0 to 100%FS Deviation value alarm: -100 to 100%FS) (Option)
		Upper limit of alarm 1 and 2	
		Lower limit of alarm 1 and 2	

[Description]











- These parameters are used to for settings of alarm 1 and 2.
- When the alarm type ($ALN1$ or $ALN2$) is set to 0 to 15, alarms 1 and 2 ($AL1$ and $AL2$) can be set.
- When the alarm type ($ALN1$ or $ALN2$) is set to any value other than 0 to 15, the upper and lower limits of alarm 1 and 2 ($A1-H$, $A2-H$, $A1-L$, $A2-L$) can be set.

[Note]

Setting codes (12 to 15) cannot be selected in alarm type 1 ($ALN1$).

Related parameters: $ALN1$, $ALN2$ (page 40)
 $A1-H$, $A2-H$ (page 53)
 $dLY1$, $dLY2$ (page 49)
 $A1oP$, $A2oP$ (page 54)

[Setting example] Setting the operation value of alarm 2 to -10°C











Display	Operating procedure
	1. Press and hold the SEL key for one second. $Stby$ will be displayed on the PV display.
	
	2. Press the  key to display $AL2$.
	3. Press the SEL key once. The current setting (10) flashes on the SV display.
	4. Press the  or  keys to display -10 .
	5. Press the SEL key once. -10 will stop flashing and will be registered for $AL2$. After that, the controller will operate with the operation value of alarm 2 being -10°C .
	6. If you want to display the operation status, press and hold the SEL key for two seconds.

LoL Key lock (Setting range: 0–5)

[Description]

- This parameter makes the set values of parameters unchangeable. However, the parameter name and the set values can be displayed.
- To reset the key lock, change to 0.
- Even though the key lock is set, control and alarm functions can operate properly.
- There are six levels of the key lock:
 - 0 : Unlocked (reset)
 - 1 : All settings are unchangeable from the controller, but changeable via communication.
 - 2 : Only the SV is changeable from the controller, and all settings are changeable via communication.
 - 3 : All settings are changeable from the controller, but unchangeable via communication.
 - 4 : All settings are unchangeable from the controller or via communication.
 - 5 : Only the SV is changeable from the controller, but all settings are unchangeable via communication.

[Setting example] Setting the key lock to “2”







Display	Operating procedure
 	<p>1. Press and hold the SEL key for one second. 5rb4 will be displayed on the PV display.</p>
	<p>2. Press the  key to display LoL.</p>
	<p>3. Press the SEL key once. The current setting (0) flashes on the SV display.</p>
	<p>4. Press the  or  keys to display 2.</p>
	<p>5. Press the SEL key once. 2 will stop flashing and will be registered for LoL. After that, any setting other than the SV cannot be changed from the front panel.</p>
	<p>6. If you want to display the operation status, press and hold the SEL key for two seconds.</p>

P Proportional band (Setting range: 0.0 to 999.9% of the measured range)

[Description]

- To select the ON/OFF control (two-position control), set **P** to 0.0. It is not necessary to set **L** and **d**.
- **P** can be automatically set by the auto-tuning operation.
- When **P** is too small, control will be unstable, and when **P** is too large, the response will be delayed.
- Set the hysteresis of the ON/OFF control (two-position control) in the parameter **HYS**.
- If auto-tuning is run after the ON/OFF control is selected, the ON/OFF control changes to the PID control. To keep the ON/OFF control selected, do not execute the auto-tuning.

[Setting example] Changing the proportional band from 5.0% to 15.0%















Display	Operating procedure
	<p>1. Press and hold the [SEL] key for three seconds. P will be displayed on the PV display.</p>
	
	<p>2. Press the [SEL] key once. The current setting (50) flashes on the SV display.</p>
	<p>3. Press the [▲] or [▼] keys to display 150.</p>
	<p>4. Press the [SEL] key once. 150 will stop flashing and will be registered for P. After that, the controller will operate with P being 15.0%.</p>
	<p>5. If you want to display the operation status, press and hold the [SEL] key for two seconds.</p>

 Integral time (Setting range: 0 to 3200 seconds)

[Description]

- \bar{I} can be set automatically by the auto-tuning operation.
- \bar{I} can also be set manually.
- When \bar{I} is set to 0, the integral operation does not start.
- When P is set to 0.0, this makes the setting of \bar{I} ineffective.

[Setting example] Changing the integral time from 240 seconds to 600 seconds







Display	Operating procedure
	<p>1. Press and hold the  key for three seconds. P will be displayed on the PV display.</p>
	
	<p>2. Press the  key to display \bar{I}.</p>
	<p>3. Press the  key once. The current setting (240) flashes on the SV display.</p>
	<p>4. Press the  or  keys to display 600.</p>
	<p>5. Press the  key once. 600 will stop flashing and will be registered for \bar{I}. After that, the controller will operate with \bar{I} being 600 seconds.</p>
	<p>6. If you want to display the operation status, press and hold the  key for two seconds.</p>

d Derivative time (Setting range: 0.0 to 999.9 seconds)

[Description]

- **d** can be set automatically by the auto-tuning operation.
- **d** can also be set manually.
- When **d** is set to 0, the differential operation does not start.
- When **P** is set to 0.0, this makes the setting of **d** ineffective.

[Setting example] Changing the differential time from 60.0 seconds to 50.0 seconds

Display	Operating procedure
	<p>1. Press and hold the SEL key for three seconds. P will be displayed on the PV display.</p>
	
	<p>2. Press the ▽ key to display d.</p>
	<p>3. Press the SEL key once. The current setting (600) flashes on the SV display.</p>
	<p>4. Press the △ or ▽ keys to display 500.</p>
	<p>5. Press the SEL key once. 500 will stop flashing and will be registered for d. After that, the controller will operate with d being 50.0 seconds.</p>
	<p>6. If you want to display the operation status, press and hold the SEL key for two seconds.</p>

HYS Hysteresis range for ON/OFF control (Setting range: 0 to 50%FS)

[Description]











- To select the ON/OFF control (two-position control), set P to 0.0. It is not necessary to set \bar{L} and d .
- When the hysteresis range (Range of ON/OFF control) is too small, the output may switch the ON/OFF frequently. (This may affect the life of the device to be controlled, especially when contact output is selected.)
- The unit of the set value of this parameter is °C or °F (engineering unit). The setting range varies according to the measured range of input.

[Ex] Input Thermocouple K : At measured range of 0 to 400 °C, the setting range is 0 to 200 °C.

Resistance bulb : At measured range of 0 to 150 °C, the setting range is 0 to 75 °C.

Related parameters: P (page 18)
 $ONOFF$ (page 30)

[Setting example] Changing the hysteresis range from 1 °C to 35 °C

Display	Operating procedure
      	<ol style="list-style-type: none"> 1. Press and hold the SEL key for three seconds. P will be displayed on the PV display. 2. Press the  key to display HYS. 3. Press the SEL key once. The current setting (1) flashes on the SV display. 4. Press the  or  keys to display 35 . 5. Press the SEL key once. 35 will stop flashing and will be registered for HYS . After that, the controller will operate with the hysteresis range being 35°C. 6. If you want to display the operation status, press and hold the SEL key for two seconds.

COOL

Cooling-side proportional band coefficient (Option: Available for DUAL output only) (Setting range: 0.0 to 100.0)

[Description]

- This parameter is used for setting the cooling-side proportional band. (See the figure below.)

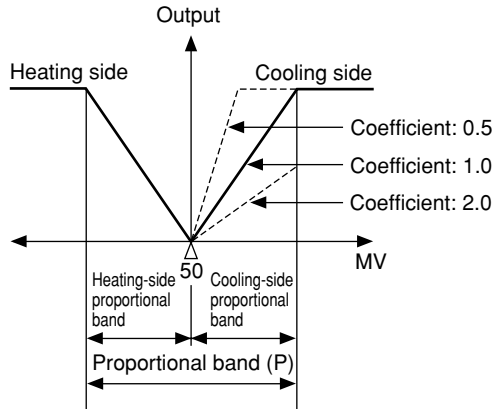

- When P is set to 0.0 and $COOL$ is set to 0.0 in the dual output type, the cooling output is as shown in the figure below. The hysteresis is fixed at 0.5% FS.

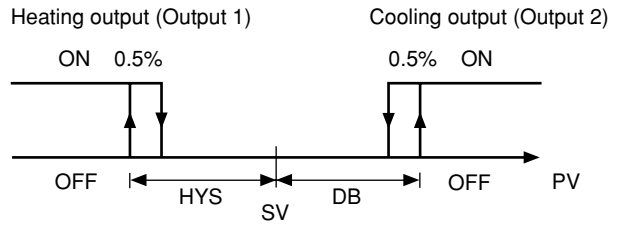

Related parameters: *HYS* (page 21)
 P (page 18)
db (page 23)

- Before setting the cooling-side proportional band, set the heating-side proportional band to an optimum value. To select the two-position control for the cooling side, set $COOL$ to 0.0.

$$\text{Cooling-side proportional band} = \frac{\text{Proportional band (P)}}{2} \times \text{Coefficient}$$

Ex) When making the proportional band of 10% of the full scale with the proportional band (P) being 50%:

$$10\% = \frac{50\%}{2} \times \text{Coefficient}$$

Consequently, the coefficient is 0.4.

[Setting example] Changing the cooling-side proportional band coefficient from 1.0 to 2.5

Display	Operating procedure
 	<ol style="list-style-type: none"> Press and hold the SEL key for three seconds. P will be displayed on the PV display.
	<ol style="list-style-type: none"> Press the ▼ key to display $COOL$.
	<ol style="list-style-type: none"> Press the SEL key once. The current setting (-10) flashes on the SV display.
	<ol style="list-style-type: none"> Press the ▲ or ▼ keys to display 25.
	<ol style="list-style-type: none"> Press the SEL key once. 25 will stop flashing and will be registered for $COOL$. After that, the controller will operate with the cooling-side proportional band coefficient being 2.5.
	<ol style="list-style-type: none"> If you want to display the operation status, press and hold the SEL key for two seconds.

db

Cooling-side proportional band shift (Dead band/Overlap band)

(Option: Available for DUAL output only) (Setting range: -50.0 to +50.0)

[Description]

- This parameter is used for shifting the cooling-side proportional band from the set value. (See the figure below.)

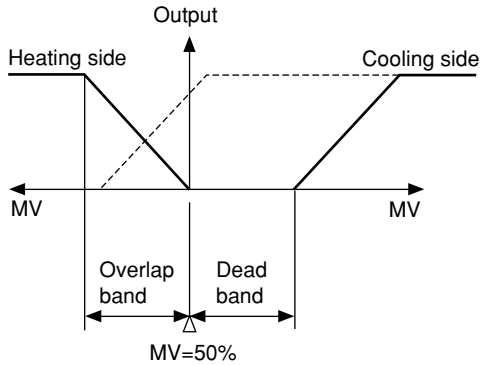

- When **db** is a positive value, it is called the "Dead band", and when it is a negative value, the "Overlap band".
- Since the unit of **db** is same one used for MV [%], if you want to set **db** in the unit of deviation [%], **db** must be converted using the equation below.

$$DB [\%] = \text{Deviation} \times \frac{100}{P} [\%]$$

Ex) When making a dead band with a deviation of 1.0 [%] from the SV while the proportional band (P) is 5.0%:

$$DB [\%] = 1.0 \times \frac{100}{5.0} = 20 [\%]$$

Consequently, set the parameter **db** to 20 [%].

- Related parameters: **P** (page 20)

[Setting example] Shifting the cooling-side proportional band by 2.0

Display	Operating procedure
	<ol style="list-style-type: none"> Press and hold the [SEL] key for three seconds. P will be displayed on the PV display. Press the [V] key to display db. Press the [SEL] key once. The current setting (00) flashes on the SV display. Press the [^] or [v] keys to display 20. Press the [SEL] key once. 20 will stop flashing and will be registered for db. After that, the controller will operate with db being 2.0 %. If you want to display the operation status, press and hold the [SEL] key for two seconds.

bAL Output offset value (Setting range: -100.0 to 100.0 %)

Ar Anti-reset windup (Setting range: 0 to 100%FS)

[Description]







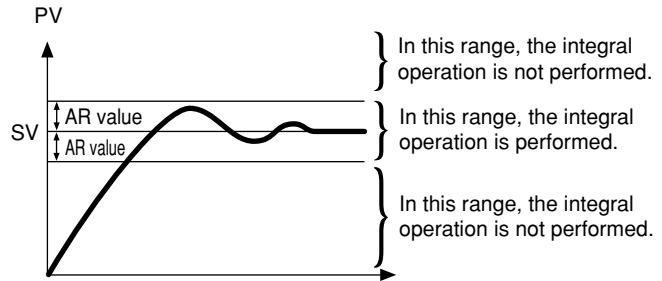



- The anti-reset windup (**Ar**) is automatically set to an optimum value by the auto-tuning operation.
By setting **bAL**, the amount of overshoot can be adjusted.

[Note]

By making use of a fuzzy control system equipped to PXR, the amount of overshoot can be minimized without setting **bAL** and **Ar**.



[Setting example] Changing the anti-reset windup from 60°C to 80°C.







Display	Operating procedure
 	<p>1. Press and hold the SEL key for three seconds. P will be displayed on the PV display.</p>
	<p>2. Press the  key to display Ar.</p>
	<p>3. Press the SEL key once. The current setting (60) flashes on the SV display.</p>
	<p>4. Press the  or  keys to display 80.</p>
	<p>5. Press the SEL key once. 80 will stop flashing and will be registered for Ar. After that, the controller will operate with the anti-reset windup being 80°C.</p>
	<p>6. If you want to display the operation status, press and hold the SEL key for two seconds.</p>

[FrL] Control algorithm (Settings: PID/FUZY/SELF)

[Description]

- This parameter is used for selecting PID control, FUZZY-PID control, or PID control with self-tuning.
- To select the PID control or FUZZY-PID control, it is necessary to set the parameters of P , I , d , and Rr manually or by the auto-tuning in advance.
- For the ON/OFF control (Two-position control), select the PID control and then set P to 0.0. For detailed information, refer to P (page 20).
- Refer to the next page for the PID control with self-tuning.

[Setting example] Changing the control system from PID to FUZZY

Display	Operating procedure
	<ol style="list-style-type: none"> 1. Press and hold the [SEL] key for three seconds. P will be displayed on the PV display. 2. Press the [V] key to display [FrL]. 3. Press the [SEL] key once. The current setting (PId) flashes on the SV display. 4. Press the [^] or [v] keys to display FUZY. 5. Press the [SEL] key once. FUZY will stop flashing and will be registered for [FrL]. After that, the controller will operate with the FUZZY control system activated. 6. If you want to display the operation status, press and hold the [SEL] key for two seconds.
	
	
	
	
	
	

[Self-tuning]

1 Function:

With the self-tuning function, PID parameters are automatically re-optimised depending on the actual condition of device to be controlled and the setting temperature (SV).

2 How to execute:

Follow the procedure shown below to set and execute the self-tuning. The self-tuning starts to run at the appropriate conditions. (See page 27)

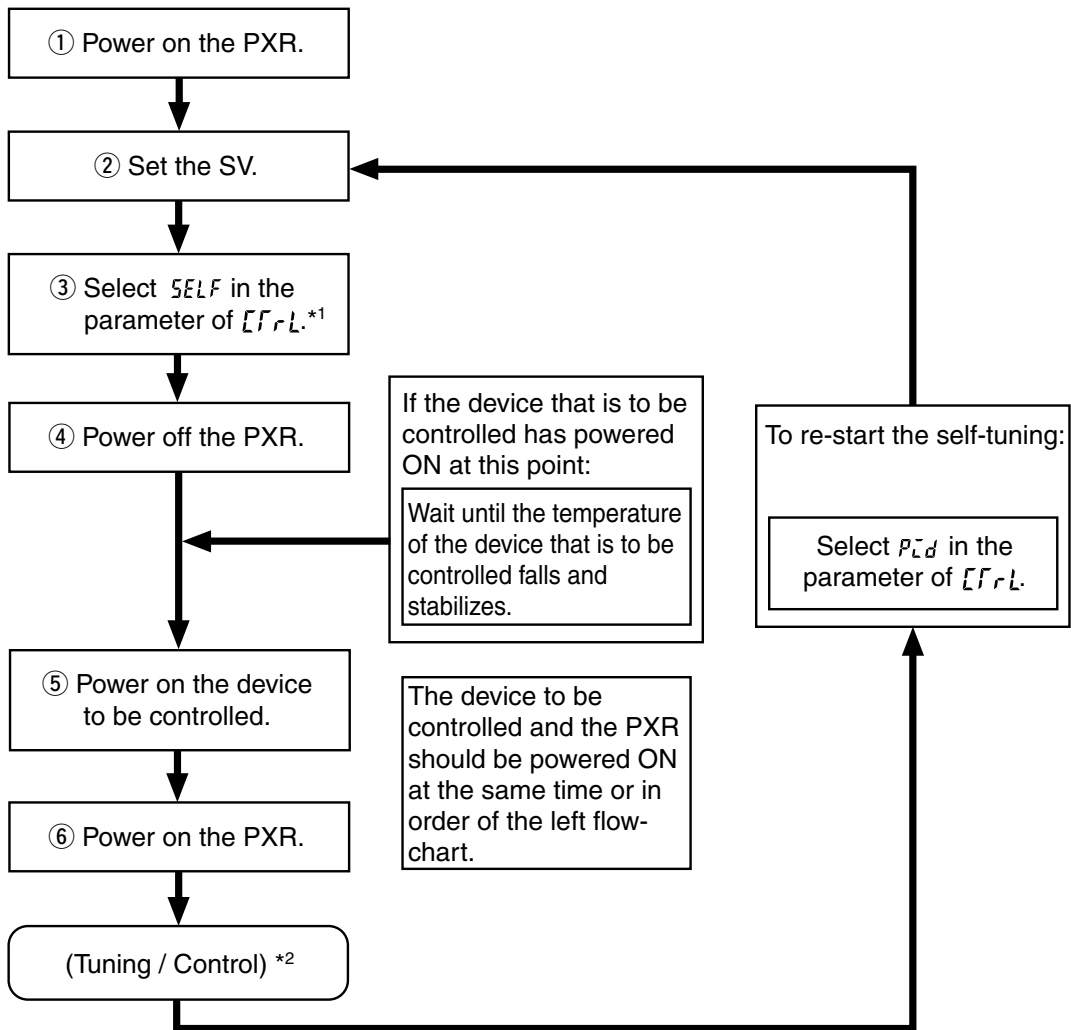

*1: How to set the parameter of CFrL:



*2: Display during self-tuning is shown below:

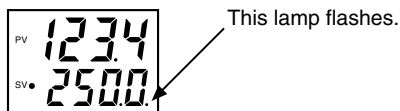

3] Conditions under which the self-tuning runs:

① At power-on:

The self-tuning runs when all of the following conditions are met.

- The SV that appears at power-on is not the same one when the P , \bar{L} , d , and R_r were set previously. (When the P , \bar{L} , d , and R_r are set by the self-tuning, auto-tuning, manual setting, and writing by communications tools at previous time)
- The (SV-PV) at power-on is larger than (the value of $P \times$ input range) or (the set value of $SLFb$).

② When the SV is changed:

The self-tuning runs when all the conditions below are met.

- The changed SV is larger than the SV that was set when the P , \bar{L} , d , and R_r were selected previously.
- The changed amount of the SV is larger than 0.
- The changed amount of the SV is larger than (the set value of $P \times$ input range) or (the set value of $SLFb$).

③ When output becomes unstable:

The self-tuning runs when control becomes unstable and the hunting of the operating output (MV) occurs. (The self-tuning runs only once as long as the SV is not changed.)

④ When the control standby mode is canceled:

The self-tuning runs by the same reason as "① At power-on".

* Only when the PXR is set to standby mode at power-on.

4] Conditions under which the self-tuning does not run:

① During control standby mode

② During two-position control (Parameter of $P = 0$)

③ During auto-tuning operation

④ During ramp-soak operation

⑤ Error display ($LLLL$ or $UUUU$ is displayed.)

⑥ During dual output (The set value of the parameter of $P-n$ l is larger than 4.)

⑦ When setting the parameters of P , \bar{L} , d , and R_r manually (including the setting written by communications tools)

5] Conditions under which the self-tuning is suspended:

① At the condition described in 4] shown above

② When the SV is changed during self-tuning operation

③ When the self-tuning operation can not be completed within approx. 9 hours

6] Caution

① Once the PID constant is set, the self-tuning does not operate at next power-on as long as the SV is not changed.

② For an accurate tuning, be sure to power on the device to be controlled before or at the same time as the PXR is powered on. If the PXR has to be powered on first for reasons of the system configuration, perform the auto-tuning with the PID or FUZZY control.

③ If the device to be controlled is powered on under temperature change (especially when it rises), accurate tunings can not be performed. Be sure to power on the PXR when the temperature of device to be controlled is stabilized.

④ The self-tuning does not run for cooling system control under Direct Action output (Parameter $P-n$ $l = 2$ or 3).

⑤ In case the control is not stable after performing the self-tuning, change the algorithm to the PID or FUZZY control and perform the auto-tuning.

7 Reference [About the self-tuning method]

The PID constant is calculated in one of the following two methods.

The method is selected automatically depending on the characteristics of the device to be controlled.

- Step response method
- Limit cycle method

The following figures show the operations at power-on and changing the SV, and under unstable control.

① Operations at power-on

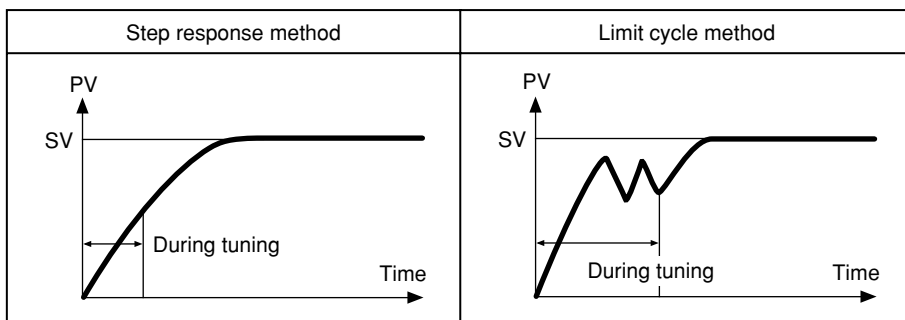

② Operations at changing the SV

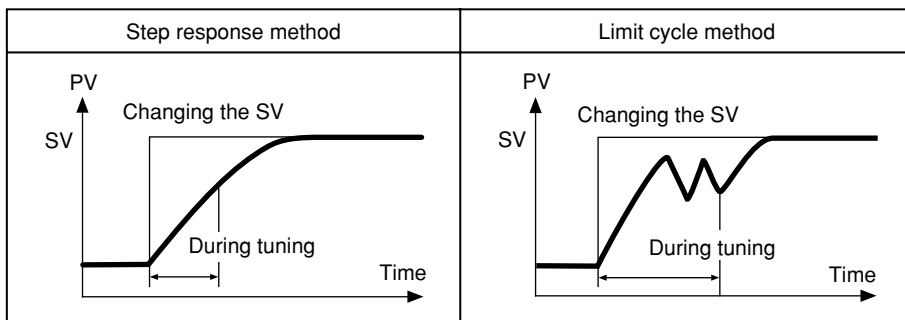

③ Operation under unstable control

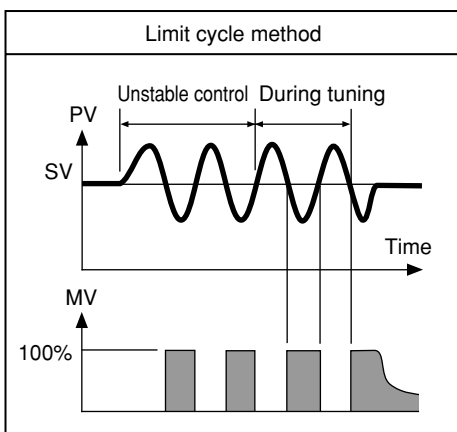











5Lfb PV (Measured value) stable range (Setting range: 0 to 100%FS)

[Description]

- Self-tuning logic recognizes that control is stable if PV is staying within the $SV \pm 5Lfb$.
- It is not necessary to set this parameter under normal conditions.

[Setting example] Changing the PV stable range from 2 to 3

Display	Operating procedure
	<p>1. Press and hold the SEL key for three seconds. P will be displayed on the PV display.</p>
	
	<p>2. Press the  key to display 5Lfb .</p>
	<p>3. Press the SEL key once. The current setting (2) flashes on the SV display.</p>
	<p>4. Press the  or  keys to display 3 .</p>
	<p>5. Press the SEL key once. 3 will stop flashing and will be registered for 5Lfb. After that, the controller will operate with the PV range being 3.</p>
	<p>6. If you want to display the operation status, press and hold the SEL key for two seconds.</p>



HYS (Hysteresis) mode at ON/OFF control (Settings: oFF/on)

[Description]

- This parameter is used for selecting the hysteresis operation mode at ON/OFF control.

oFF: Starts the ON/OFF control at the values of $SV + \frac{HYS}{2}$ and $SV - \frac{HYS}{2}$.

on: Starts the ON/OFF control at the values of SV and SV+HYS, or SV and SV-HYS.

- Default setting: ON

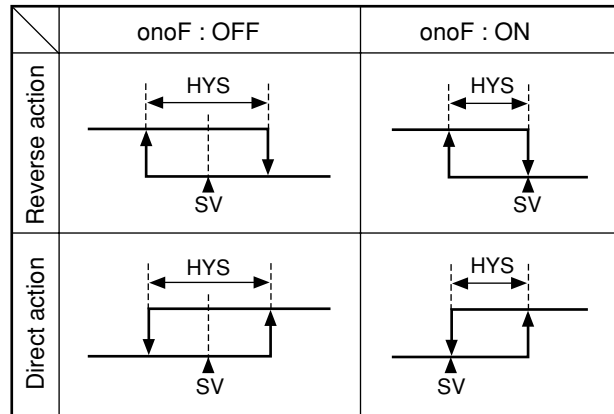

[Setting example] Setting the hysteresis mode to ON

Display	Operating procedure
	<ol style="list-style-type: none"> Press and hold the [SEL] key for three seconds. P will be displayed on the PV display. Press the [V] key to display onoF. Press the [SEL] key once. The current setting (oFF) flashes on the SV display. Press the [V] key to display on. Press the [SEL] key once. on will stop flashing and will be registered for onoF. After that, the controller will operate with the hysteresis being as shown in the figure of ON above. If you want to display the operation status, press and hold the [SEL] key for two seconds.



Cycle time of control output 1 (Setting range: 1 to 150 seconds)

[Description]

- This parameter is applicable for to the contact output and SSR-driving output.
- While input is within the proportional band, output changes between ON and OFF in cycles. These cycles are called cycle time.

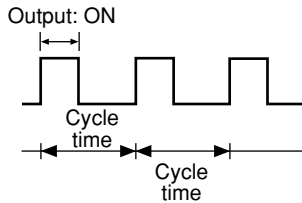

- Do not set this parameter to "0".

For contact output:

The higher the frequency of output is, the more precise the control becomes. However a high frequency of output may shorten the life of the contacts and the device to be controlled. Be sure to adjust the proportional cycles considering controllability and the life of the device and the contacts.

Typical: 30 seconds

For SSR-driving output:

Use in short cycles if there is no problem with the device to be controlled.

Typical: 1 to 2 seconds

[Setting example] Setting the cycle time from 30 seconds to 20 seconds

Display	Operating procedure
	<ol style="list-style-type: none"> 1. Press and hold the [SEL] key for three seconds. P will be displayed on the PV display. 2. Press the [V] key to display FC. 3. Press the [SEL] key once. The current setting (30) flashes on the SV display. 4. Press the [^] or [v] key to display 20. 5. Press the [SEL] key once. 20 will stop flashing and will be registered for FC. After that, the controller will operate with the cycle time being 20 seconds. 6. If you want to display the operation status, press and hold the [SEL] key for two seconds.



Cycle time of control output 2 (Cooling-side)

(Setting range: 1 to 150 seconds) (Option: Available for DUAL output only)

[Description]

- By this parameter, the cycle time of control output 2 is set.
- While input is within the proportional band, output changes between ON and OFF in cycles. These cycles are called cycle time.

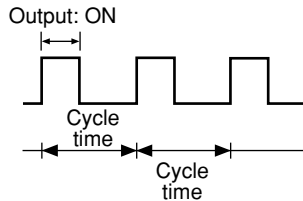











For contact output:

The higher the frequency of output is, the more precise the control becomes. However a high frequency of output may shorten the life of the contacts and the device to be controlled. Be sure to adjust the cycle time considering controllability and the life of the device and the contacts.

Typical: 30 seconds

- Do not set this parameter to "0".

[Setting example] Setting the cooling-side cycle time from 30 seconds to 20 seconds

Display	Operating procedure
 	<ol style="list-style-type: none"> 1. Press and hold the SEL key for three seconds. P will be displayed on the PV display.
	<ol style="list-style-type: none"> 2. Press the  key to display rC2.
	<ol style="list-style-type: none"> 3. Press the SEL key once. The current setting (30) flashes on the SV display.
	<ol style="list-style-type: none"> 4. Press the  or  key to display 20.
	<ol style="list-style-type: none"> 5. Press the SEL key once. 20 will stop flashing and will be registered for rC2. After that, the controller will operate with the cooling-side cycle time being 20 seconds.
	<ol style="list-style-type: none"> 6. If you want to display the operation status, press and hold the SEL key for two seconds.

$P-n\Omega$ Input signal code (Setting range: 1 to 16)

[Description]

- This parameter is used for selecting input signals. Input signal varies depending on the sensors (2 types below). Set a code that corresponds to the sensor you use.
 - Type I : Thermocouples (9 kinds of signals)
Resistance bulbs (1 kind of signal)
 - Type II : Voltage, current
- Input signals can be selected within the same type. It is impossible to select input signals of a different type.
- For type II, when changing from the voltage input to the current input, connect the supplied resistance of 250 Ω between terminals ⑰ and ⑱ as well as changing the code. When changing from the current input to the voltage input, remove the resistance of 250 Ω as well as changing the code.

[Note]











After changing the codes, power off the PXR, and then power it on again.

- Input signals and codes

① Input signals code table

Type	Input signal	Code $P-n\Omega$
I	Resistance bulb (RTD)	1
	• Pt 100	
	Thermocouple	2
	• J	
	• K	
	• R	
	• B	
	• S	
	• T	
• E	8	
• N	12	
• PL-II	13	
II	1 to 5 V, 4 to 20mA DC	16

[Setting example] Changing from thermocouple K to thermocouple T in Type I

Display	Operating procedure
      	<ol style="list-style-type: none"> Press and hold the SEL key for three seconds. P will be displayed on the PV display. Press the  key to display $P-n\Omega$. Press the SEL key once. The current setting (3) flashes on the SV display. Press the  or  key to display 7. Press the SEL key once. 7 will stop flashing and will be registered for $P-n\Omega$. After that, the controller will operate with the kind of input signals being thermocouple T. If you want to display the operation status, press and hold the SEL key for two seconds.

P-5L

Setting the the measuring range (Input range) (Setting range: -1999 to 9999)

P-5U

P-F

Selection °C / °F (Settins: °C / °F)

[Description]

- These parameters is used for setting the lower and upper limits of the measured range and unit of temperature.
- A decimal point position can be set in the parameter of P-dP.
- For the current and voltage inputs, $\bar{0}$, $\bar{1}$ and $\bar{2}$ can be set for P-dP, and for other inputs, $\bar{0}$ and $\bar{1}$ can be set for P-dP.
- See the right table for input range.

② Input range table (Standard range)

Input type		Range (°C)	With / without a decimal point (°C)*	Range (°F)	With / without a decimal point (°F)*
Resistance bulb JIS (IEC)	Pt100Ω	0 to 150	O	32 to 302	O
		0 to 300	O	32 to 572	O
		0 to 500	O	32 to 932	O
		0 to 600	O	32 to 1112	X
		-50 to 100	O	-58 to 212	O
		-100 to 200	O	-148 to 392	O
Thermocouple	J J K K K R B S T T E E N PL-II	0 to 400	O	32 to 752	O
		0 to 800	O	32 to 1472	X
		0 to 400	O	32 to 752	O
		0 to 800	O	32 to 1472	X
		0 to 1200	X	32 to 2192	X
		0 to 1600	X	32 to 2912	X
		0 to 1800	X	32 to 3272	X
		0 to 1600	X	32 to 2912	X
		-150 to 200	O	-238 to 392	X
		-150 to 400	O	-238 to 752	X
		0 to 800	O	32 to 1472	X
		-150 to 800	O	-238 to 1472	X
		0 to 1300	X	32 to 2372	X
0 to 1300	X	32 to 2372	X		
Direct-current voltage	1 to 5 V DC	-1999 to 9999 (Scaling is possible)			

* O: with
X: without

* For 4 to 20 mA DC input, connect a resistance of 250Ω between terminals ⑰ and ⑱ to change the input to the 1 to 5 V DC input.

[Note]

















The input accuracy is ±0.5%FS±1 digit except the cases shown below.

Thermocouple R at 0 to 400 °C: } In this range, this controller may display a wrong process value because of the characteristics of the sensor.

Thermocouple B at 0 to 500 °C: }

Other kinds of thermocouples: ±0.5% FS ± 1 digit ± 1 °C

[Setting example] Changing the measuring range from 0°C to 150°C to -100°C to 200°C (Pt100) _____

Display	Operating procedure
	<p>1. Press and hold the SEL key for three seconds. <i>P</i> will be displayed on the PV display.</p>
	
	<p>2. Press the  key to display <i>P-5L</i>.</p>
	<p>3. Press the SEL key once. The current setting (<i>0</i>) flashes on the SV display.</p>
	<p>4. Press the  or  key to display <i>-100</i>.</p>
	<p>5. Press the SEL key once. <i>-100</i> will stop flashing and will be registered for <i>P-5L</i>.</p>
	<p>6. Press the  key to display <i>P-5U</i> on the PV display.</p>
	<p>7. Press the SEL key once. The current setting (<i>150</i>) flashes on the SV display.</p>
	<p>8. Press the  or  key to display <i>200</i>.</p>
	<p>9. Press the SEL key once. <i>200</i> will be registered for <i>P-5U</i>. After that, the controller will operate with the measured range being -100°C to 200°C.</p>
	<p>10. If you want to display the operation status, press and hold the SEL key for two seconds.</p>

P-dP Decimal point position (Settings: 0 / 1 / 2)

[Description]

- This parameter is used for selecting the decimal point position for the PV (Measured value). Related parameters: **P-SL** (page 34)
P-SU (page 34)



- "0" (No digit after decimal point)
- "1" (1 digit after decimal point)
- "2" (2 digit after decimal point. This is valid only for the voltage and current inputs)

[Setting example] Changing the decimal point position setting from 0 to 1











Display	Operating procedure
 	<p>1. Press and hold the [SEL] key for three seconds. P will be displayed on the PV display.</p>
	<p>2. Press the [V] key to display P-dP.</p>
	<p>3. Press the [SEL] key once. The current setting (0) flashes on the SV display.</p>
	<p>4. Press the [^] key to display 1.</p>
	<p>5. Press the [SEL] key once. 1 will stop flashing and will be registered for P-dP. After that, the controller will operate with one decimal point position displayed.</p>
	<p>6. If you want to display the operation status, press and hold the [SEL] key for two seconds.</p>

PUOF PV (Measured value) offset (Setting range: -10 to 10%FS)

[Description]

- With this function, predetermined value is added to the input reading. This parameter is used for adjusting PXR's indication so that it becomes same as the one of the other instruments like recorder.
- The PXR operates at the displayed PV (the value to which the PV offset value is added).

[Setting example] Adding the PV offset value of 5°C to the input value of 1200 °C











Display	Operating procedure
	<p>1. Press and hold the SEL key for three seconds. <i>p</i> will be displayed on the PV display.</p> <p>2. Press the  key to display <i>PUOF</i>.</p> <p>3. Press the SEL key once. The current setting (<i>0</i>) flashes on the SV display.</p> <p>4. Press the  or  key to display <i>5</i>.</p> <p>5. Press the SEL key once. <i>5</i> will stop flashing and will be registered for <i>PUOF</i>. After that, the controller will operate so that the value to which the offset value of 5°C is added can be brought close to the set value.</p> <p>6. If you want to display the operation status, press and hold the SEL key for two seconds.</p>
	
	
	
	
	
	

SVDF SV (Setting value) offset (Setting range: -50 to 50%FS)

[Description]

- With this function, predetermined value is added to the original SV. This parameter is used to eliminate the offset that occurs in performing P control.
- The PXR operates based on the SV to which the SV offset value is added.
- Alarm judgment is made by the displayed SV to which the SV offset value is not added.

[Setting example] Adding the SV offset value of 9°C to the currently set value

Display	Operating procedure
 	<p>1. Press and hold the SEL key for three seconds. <i>p</i> will be displayed on the PV display.</p>
	<p>2. Press the  key to display SVDF.</p>
	<p>3. Press the SEL key once. The current setting (<i>0</i>) flashes on the SV display.</p>
	<p>4. Press the  or  key to display <i>9</i>.</p>
	<p>5. Press the SEL key once. <i>9</i> will stop flashing and will be registered for SVDF. (The displayed SV remains unchanged.) After that, the controller will operate at the SV value to which the SV offset value of 9°C is added.</p>
	<p>6. If you want to display the operation status, press and hold the SEL key for two seconds.</p>

P-dF Time constant of input filter (Setting range: 0.0 to 900.0 seconds)

[Description]

- This parameter is used for reducing the fluctuation of input signal (filter function).

For example, when the input filter constant is set to 5 seconds, the PV changes as shown in right figure while input changes from 0 to 100% suddenly. It takes 5 seconds for the PV to change from 0 to 63.2%.

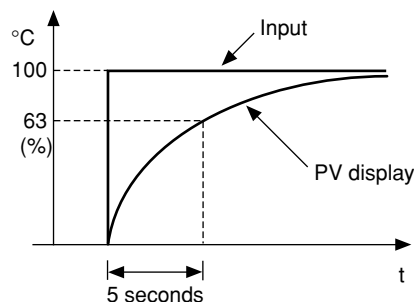
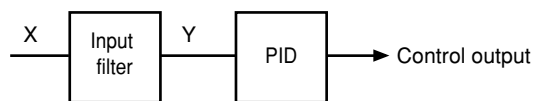

[Note]

The factory default setting is 5.0 (5 seconds). Do not change this parameter as long as changing is not of absolute necessity.

[Setting example] Changing the filter constant from 5.0 (5 seconds) to 10.0 (10 seconds)

Display	Operating procedure
	<ol style="list-style-type: none"> Press and hold the SEL key for three seconds. p will be displayed on the PV display. Press the key to display P-dF. Press the SEL key once. The current setting (50) flashes on the SV display. Press the or key to display 100. Press the SEL key once. 100 will stop flashing and will be registered for P-dF. After that, the controller will operate with the filter constant being 10.0. If you want to display the operation status, press and hold the SEL key for two seconds.

ALN1, ALN2 Alarm types (Setting range: 0 to 34) (Option)

[Description]

- These parameters is used for selecting the operation types of Alarms 1 and 2.
- Alarm1 is activated in the same way as Alarm2 except for codes 12 to 15. (Codes 12 to 15 cannot be selected for Alarm1 .)
- When any code of 12 to 15 is selected for Alarm 2, Alarm 2 is activated and Alarm 1 is canceled. "Alarm hysteresis", "Delay time", and "Alarm latch" can be selected in Alarm 2 settings.
- The display of the parameter in which the alarm value is set varies depending on the alarm operation types.

[Note]

- Since the alarm set value may change after changing the alarm operation types, be sure to set the alarm set value again.
- After changing the alarm operation types, power the PXR off, and then on.
- Setting code 0 indicates "No alarm".

Related parameters: *ALHY*, *ALHY* (page 53)
ALOP, *ALOP* (page 54)
AL1, *AL2* (page 16)
DLY1, *DLY2* (page 49)

[Note] Alarm set value and alarm operations

		Alarm set value (AL)	
		Plus setting	Minus setting
Absolute value	Upper limit		Disabled
	Lower limit		Disabled
Deviation value	Upper limit		
	Lower limit		

[Setting example] Changing the alarm type of Alarm 2 from upper-limit deviation to the upper-limit deviation with hold

Display	Operating procedure
	<ol style="list-style-type: none"> 1. Press and hold the [SEL] key for three seconds. <i>p</i> will be displayed on the PV display. 2. Press the [V] key to display <i>ALN2</i>. 3. Press the [SEL] key once. The current setting (<i>5</i>) flashes on the SV display. 4. Press the [<] key to display <i>8</i>. 5. Press the [SEL] key once. <i>8</i> will stop flashing and will be registered for <i>ALN2</i> . After that, the controller will operate with Alarm 2 of upper limit deviation with hold. 6. If you want to display the operation status, press and hold the [SEL] key for two seconds.

[Alarm type list]

The table below shows the meaning of symbols in the following operation figures.

Alarm type	Alarm 1		Alarm 2	
	Display symbol	Screen name	Display symbol	Screen name
0~15	AL1	Set value of Alarm 1	AL2	Set value of Alarm 2
16~31	A1-L	Lower-limit of set value of Alarm 1	A2-L	Lower-limit of set value of Alarm 2
	A1-H	Upper-limit of set value of Alarm 1	A2-H	Upper-limit of set value of Alarm 2

- Alarm 1 is activated in the same way as Alarm 2 except codes 12 to 15. (Codes 12 to 15 cannot be selected for Alarm 1. If any of them is set, it is recognized as code 0, which indicates "No alarm".)
- When any code of 12 to 15 is selected for Alarm 2, Alarm 2 is activated and Alarm 1 is not raised. "Alarm hysteresis", "Delay time", and "Alarm latch" can be selected in Alarm 2 settings.
- The display of the parameter in which the alarm value is set varies depending on the alarm operation types.
- Since the alarm set value may change after changing the alarm operation types, confirm the alarm set value. (Note that this is not abnormal.)

• Alarm codes for standard types

	ALM1	ALM2	Alarm type	Operation figure
	0	0	No alarm	
Absolute value alarm	1	1	Upper-limit absolute value	
	2	2	Lower-limit absolute value	
	3	3	Upper-limit absolute value (with hold)	
	4	4	Lower-limit absolute value (with hold)	
Deviation value alarm	5	5	Upper-limit deviation	
	6	6	Lower-limit deviation	
	7	7	Upper and lower limits deviation	
	8	8	Upper-limit deviation (with hold)	
	9	9	Lower-limit deviation (with hold)	
	10	10	Upper and lower limits deviation (with hold)	

	ALM1	ALM2	Alarm type	Operation figure
Range alarm	11	11	Range upper and lower limits deviation (ALM1/2 independent operation)	
	-	12	Range upper and lower limits absolute value	
	-	13	Range upper and lower limits deviation	
	-	14	Range upper limit absolute value and lower limit deviation	
	-	15	Range upper limit deviation and lower limit absolute value	

• Timer codes

	ALM1	ALM2	Alarm type	Operation figure
Timer	32	32	ON-delay timer	
	33	33	OFF-delay timer	
	34	34	ON/OFF-delay timer	

• Alarm codes with dual set values

	ALM1	ALM2	Alarm type	Operation figure
Upper and lower limits alarm	16	16	Upper and lower limits absolute value	
	17	17	Upper and lower limits deviation	
	18	18	Upper limit absolute value and lower limit deviation	
	19	19	Upper limit deviation and lower limit absolute value	
	20	20	Upper and lower limits absolute value (with hold)	
	21	21	Upper and lower limit deviation (with hold)	
	22	22	Upper limit absolute value and lower limit deviation (with hold)	
	23	23	Upper limit deviation and lower limit absolute value (with hold)	

	ALM1	ALM2	Alarm type	Operation figure
Range alarm	24	24	Range upper and lower limits absolute value	
	25	25	Range upper and lower limits deviation	
	26	26	Range upper limit absolute value and lower limit deviation	
	27	27	Range upper limit deviation and lower limit absolute value	
	28	28	Range upper and lower limits absolute value (with hold)	
	29	29	Range upper and lower limits deviation (with hold)	
	30	30	Range upper limit absolute value and lower limit deviation (with hold)	
	31	31	Range upper limit deviation and lower limit absolute value (with hold)	

dLYn: The delay time of Alarms 1 and 2 or timers 1 and 2

ALn: The set value of Alarms 1 and 2

AL1: The set value of Alarm 1

AL2: The set value of Alarm 2

PFn Selecting ramp-soak execute type (Settings: 1 / 2 / 3) (Option)

[Description]

- The ramp-soak execute type become effective when the ramp-soak operation is changed from *OFF* to *run*.
- Setting range
 - 1* : Performs 1st to 4th segments.
 - 2* : Performs 5th to 8th segments.
 - 3* : Performs 1st to 8th segments.

[Note]

- The change of the ramp-soak execute type are not effective if they are changed during RUN or HOLD.
- Types 1 and 2 cannot run one after another.
- Once *SV-1* to *SV-8* are set, when the SV limiter is set the set values of *SV-1* to *SV-8* are not changed, but the SV displayed during ramp-soak operation is affected by the SV limiter.

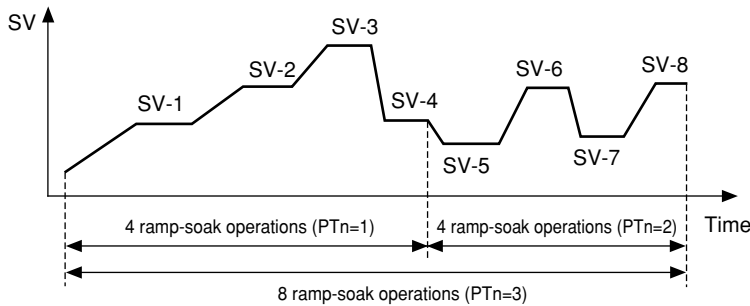

[Setting example] Changing the ramp-soak execute type from 1 to 3

Display	Operating procedure
	<ol style="list-style-type: none"> 1. Press and hold the SEL key for three seconds. <i>p</i> will be displayed on the PV display. 2. Press the ∇ key to display <i>PFn</i>. 3. Press the SEL key once. The current setting (<i>1</i>) flashes on the SV display. 4. Press the ∧ key to display <i>3</i>. 5. Press the SEL key once. <i>3</i> will stop flashing and will be registered for <i>PFn</i>. After that, the controller will operate in ramp-soak type 3 6. If you want to display the operation status, press and hold the SEL key for two seconds.

5rAr Ramp-soak status display (Display only)

5u-1 to **5u-8** 1st to 8th target SV (Setting range: $5u-L$ to $5u-H$) (Option)

rAr to **rAr8** 1st to 8th ramp segment time (Setting range: 0 to 99h 59min) (Option)

rAs to **rAs8** 1st to 8th soak segment time (Setting range: 0 to 99h 59min) (Option)

Mod Ramp-soak modes (Setting range: 0 to 15) (Option)

[Description]

- By these parameters, the SV (Set value) are automatically changed over time according to the patterns set in advance as shown in the figure below. A maximum of 8 ramp-soak segments can be set in PXR.
- The first ramp starts from the PV (Measured value) just before performing the program.
- The program can also be started at power-on automatically (Power-on start function).
- A maximum of eight ramp-soak segments can be set. It is also possible to set 4 ramp-soak segments twice instead.
- If the following parameters are changed under ramp-soak operation, the ramp-soak pattern is changed to the new setting.

- $5u-1$ to $5u-8$
- rAr to $rAr8$
- rAs to $rAs8$
- Mod

[Parameters]

In order to execute these functions, it is necessary to set the programs in advance. To set the programs, set the SV (Setting value) and time desired for the parameters shown in the table on next page.

Related parameters: rAn (page 43)
 rOb (page 12)
 $5u-L$ (page 48)
 $5u-H$ (page 48)

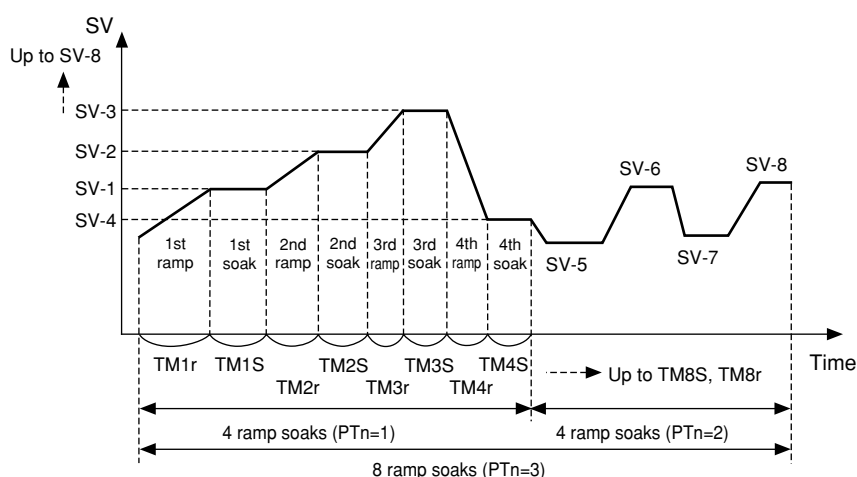

Parameter display symbol	Name		Description	Factory default settings	Remark
<i>STAT</i>	STAT	Current program status	Displays the ramp-soak current status. This parameter is only for display, and cannot set anything. <i>OFF</i> : OFF <i>1-rP</i> to <i>8-rP</i> : Under the 1st to 8th ramp operation <i>1-Sk</i> to <i>8-Sk</i> : Under the 1st to 8th soak operation <i>End</i> : Ends the program	—	No symbol appears when the ramp-soak model is not selected.
<i>SV-1</i> to <i>SV-8</i>	SV-1 to SV-8	1st to 8th target SV	Sets the target value (SV) of each ramp segment (Setting range: <i>SV-L</i> to <i>SV-H</i>)	0%FS	
<i>TM1r</i> to <i>TM8r</i>	TM1r to TM8r	1st to 8th ramp segment time	Sets the ramp time for each segment (Setting range: 0 to 99h 59min)	0.00	
<i>TM1s</i> to <i>TM8s</i>	TM1s to TM8s	1st to 8th soak segment time	Sets the soak time for each segment (Setting range: 0 to 99h 59min)	0.00	
<i>Mod</i>	Mod	Ramp-soak mode	Selects the modes of ramp-soak function. Set to "0" under normal conditions	0	

[MODE code list]

MOD	Power-on start	Output at the END	Output at OFF	Repeat operation
0	OFF	Continuous control	Continuous control	OFF
1	OFF	Continuous control	Continuous control	ON
2	OFF	Continuous control	Standby mode	OFF
3	OFF	Continuous control	Standby mode	ON
4	OFF	Standby mode	Continuous control	OFF
5	OFF	Standby mode	Continuous control	ON
6	OFF	Standby mode	Standby mode	OFF
7	OFF	Standby mode	Standby mode	ON
8	ON	Continuous control	Continuous control	OFF
9	ON	Continuous control	Continuous control	ON
10	ON	Continuous control	Standby mode	OFF
11	ON	Continuous control	Standby mode	ON
12	ON	Standby mode	Continuous control	OFF
13	ON	Standby mode	Continuous control	ON
14	ON	Standby mode	Standby mode	OFF
15	ON	Standby mode	Standby mode	ON

[Description of functions]

1. Power-on start: The ramp-soak operation starts to run from the current PV value.
2. Output at END: The output status at the END of the ramp-soak operation.
3. Output at OFF: The output status while the ramp-soak operation is set to OFF.
4. Repeat operation: This function makes the ramp-soak operation to continue after one cycle of ramp-soak operation is completed. At the event of Repeat operation: OFF, the SV that is set in the final cycle is kept.

* Standby mode: Output: control output OFF or -3%
 Alarm: OFF
 Control: OFF

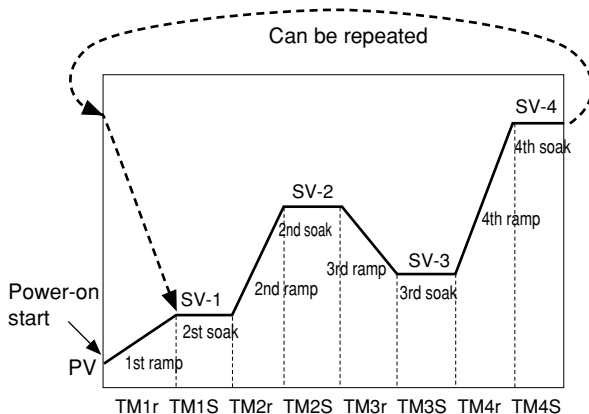

[Ramp]

The segment in which the set value changes toward the target value.

[Soak]

The segment in which the set value is always the target value and remains unchanged.

- The segment in which both the ramp time and soak time are set to "0" is skipped.

[Ex]

SV-1: 50	SV-2:200	SV-3:100
TM1r:0.10	TM2r:0.00	TM3r:1.00
TM1S:0.05	TM2S:0.00	TM3S:0.75

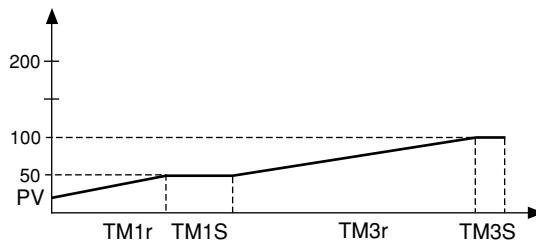

- The SV limit function is valid even while the ramp-soak operation is running.

Although the set value (SV-n) remains unchanged, the SV under ramp-soak operation is affected by the limit function. Therefore, the pattern is as shown in the figure on right, and it may not change according to the original set time.

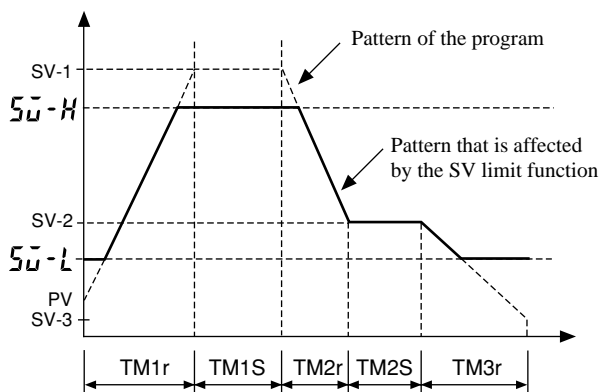

[Setting example] Setting the 1st target SV to 400°C

Display	Operating procedure
	<ol style="list-style-type: none"> Press and hold the [SEL] key for three seconds. p will be displayed on the PV display. Press the [V] key to display SV-1. Press the [SEL] key once. The current setting (0) flashes on the SV display. Press the [^] key to display 400. Press the [SEL] key once. 400 will stop flashing and will be registered for SV-1. If you want to display the operation status, press and hold the [SEL] key for two seconds.

P-n1 Specifying control action, and output direction at input burn-out (Setting range: 0 to 19)

[Description]

- This parameter specifies action (Single/Dual and Heating/Cooling), and output direction at input burn-out.
- The standard model (single output) or the heating/cooling control output (dual output) are available.
- There is difference of hardware between the standard model and the heating/cooling control output model. Set the code that is applicable to your controller.
- In general, reverse action is applied for the heating process and direct action is applied for the cooling process.







* "Burn-out output" means the output direction at input burn-out.

* The lower limit of a burn-out output indicates that output is set to OFF, or 4mA or less. The upper limit indicates that output is set to ON, or 20mA or more.

• Control operation code table

Code (P-n1)	Model	Control action		Burn-out output*			
		Output 1	Output 2	Output 1	Output 2		
0	Standard (single)	Reverse	...	Lower limit	...		
1				Upper limit			
2		Direct		Lower limit			
3				Upper limit			
4	Heating /Cooling (dual)	Reverse	Direct	Lower limit	Lower limit		
5				Upper limit	Upper limit		
6				Lower limit			
7				Upper limit			
8				Direct		Lower limit	Lower limit
9						Upper limit	Upper limit
10		Lower limit					
11		Upper limit					
12		Reverse	Reverse		Lower limit	Lower limit	
13					Upper limit	Upper limit	
14				Lower limit			
15				Upper limit			
16	Direct			Lower limit	Lower limit		
17				Upper limit	Upper limit		
18		Lower limit					
19		Upper limit					

[Setting example] Changing the "Reverse/Lower limit for burn-out output" to the "Direct/Upper limit for burn-out output"

Display	Operating procedure
     	<ol style="list-style-type: none"> 1. Press and hold the [SEL] key for five seconds. P-n1 will be displayed on the PV display. 2. Press the [SEL] key once. The current setting (0) flashes on the SV display. 3. Press the [▲] or [▼] keys to display 3. 4. Press the [SEL] key once. 3 will stop flashing and will be registered for P-n1. After that, the controller will operate with the "Direct/Upper limit for burn-out output" selected. 5. If you want to display the operation status, press and hold the [SEL] key for two seconds.

SV-L SV (Setting value) lower limiter (Setting range: 0 to 100%FS)

SV-H SV (Setting value) upper limiter (Setting range: 0 to 100%FS)

[Description]



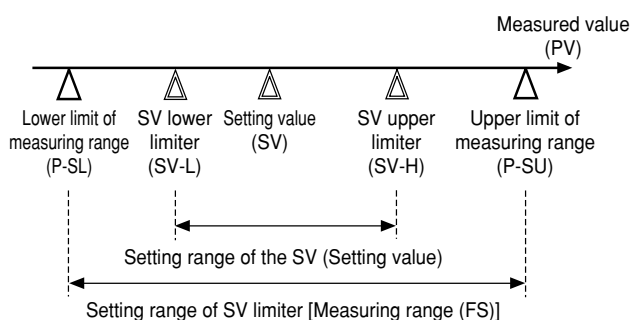







- These parameters set the setting range of the SV (Setting value).
- Both the SV under ramp-soak operation and the SV switched by the DI1 function are affected by the SV limiter.
- The SV upper and lower limiters (**SV-H**, **SV-L**) can be set within the range of the measuring values (**P-SL**, **P-SU**).



[Note]

- Before setting the parameters of **SV-H** and **SV-L**, be sure to set the following parameters.
 - Setting the lower limit of the measured range (**P-SL**)
 - Setting the upper limit of the measured range (**P-SU**)
 - Setting the decimal point position (**P-dP**)
- After changing the parameters of **P-SL**, **P-SU**, and **P-dP**, power off the PXR, and then on. Then, set the parameters of **SV-H** and **SV-L** again.
- Before setting the SV, set the parameters of **SV-H** and **SV-L**.
- Be sure to set the values of **SV-H** and **SV-L** so that **SV-H** is larger than **SV-L** or **SV-H** is the same as **SV-L**.
- Although the displayed SV is affected by the limiter immediately after setting **SV-H** and **SV-L**, the set values of **SV-1** to **SV-8** are not affected.
- When the SV limiter is set during ramp-soak operation or switching the SV with the DI1 function, the SV (SV0) that is set manually and the displayed SV are affected by the SV limiter. So, after setting the ramp-soak operation to OFF, or returning the switched SV to the original SV, the PXR operates with the SV0 affected by the SV limiter.

[Setting example] Setting the upper limiter to 100°C

Display	Operating procedure
 	<p>1. Press and hold the SEL key for five seconds. P-n 1 will be displayed on the PV display.</p>
	<p>2. Press the  key to display SV-H.</p>
	<p>3. Press the SEL key once. The current setting (400) flashes on the SV display.</p>
	<p>4. Press the  or  keys to display 100.</p>
	<p>5. Press the SEL key once. 100 will stop flashing and will be registered for SV-H. After that, the upper limit of the SV will be 100°C.</p>
	<p>6. If you want to display the operation status, press and hold the SEL key for two seconds.</p>

dLY1

dLY2

The time of ON-delay alarm or timer function (Setting range: 0 to 9999 seconds)

[Description]

ON-delay alarm

- With this function, the alarm relay is closed after the pre-determined delay time. (See operation ① shown in the figure below.)
- In case the cause of the alarm is solved within the delay time, the alarm relay is not closed. (See operation ③ shown in the figure below.)
- The alarm relay is opened regardless of this parameter. (See operation ② shown in the figure below.)

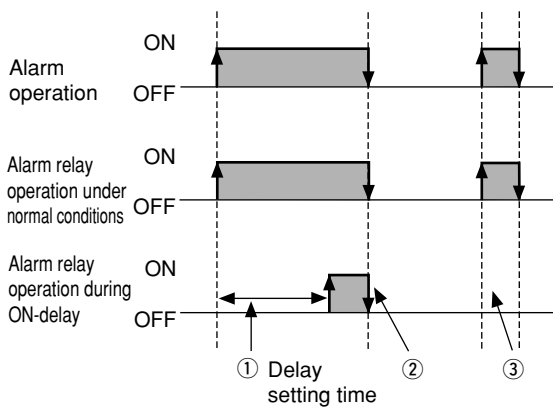

- In case the alarm is set to OFF during standby, the ON-delay operation performs again when returning to RUN.
- When the delay time is changed during ON-delay operation, the alarm is activated in the changed delay time.

Timer function

- When the ON-delay timer is selected (ALMn = 32), the relay is closed in the set time after DI input is set to ON. While the DI input stays OFF, the timer cannot be activated.
- When the OFF-delay timer is selected (ALMn = 33), the timer cannot be activated while the DI input is set to ON. The relay is closed in the set time after DI input is set to OFF.
- When the ON/OFF-delay timer is selected (ALMn = 34), the timer is activated while the DI input stays either ON or OFF.

- The timer display function shows the remaining time of timers 1 and 2.
- The set time is counted down while the ON or OFF timer is activated.
- While the ON timer is activated, the alarm relay is closed when the remaining time is 0. While the OFF timer is activated, the alarm relay is opened when the remaining time is 0.

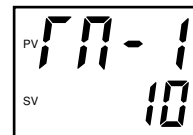

Displays the remaining time (seconds)

• ON-delay timer operation

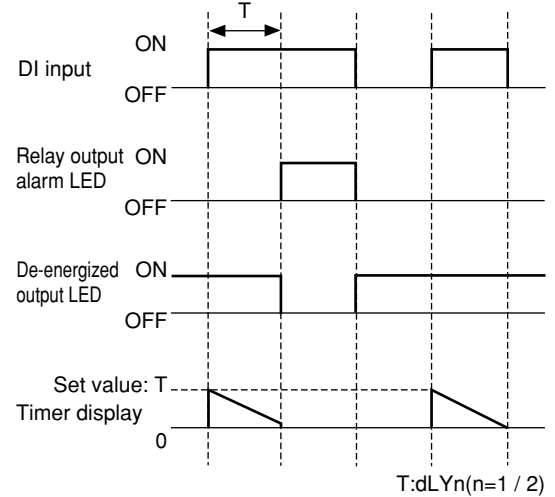





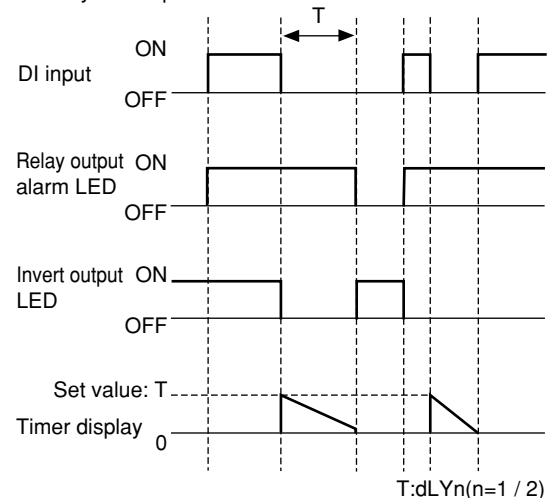





T:dLYn(n=1 / 2)

• OFF-delay timer operation



T:dLYn(n=1 / 2)

[Setting example] Setting the delay time for ON-delay alarm to 30 seconds

Display	Operating procedure
	<p>1. Press and hold the SEL key for five seconds.</p>
	<p><i>P-n l</i> will be displayed on the PV display.</p>
	<p>2. Press the  key to display <i>dL y l</i>.</p>
	<p>3. Press the SEL key once.</p> <p>The current setting (<i>0</i>) flashes on the SV display.</p>
	<p>4. Press the  or  keys to display <i>30</i>.</p>
	<p>5. Press the SEL key once. <i>30</i> will stop flashing and will be registered for <i>dL y l</i>. After that, the controller will operate with the ON-delay alarm being 30 seconds.</p>
	<p>6. If you want to display the operation status, press and hold the SEL key for two seconds.</p>

CF Displaying current detector input (Display only) (Option)

Hb Hb (Set value of heater break alarm) (Setting range: 0.0 to 50.0 A) (Option)

[Description]

- When **Hb** is set to 0.0, the HB alarm is turned OFF.
- The point at which the alarm is activated can be set in the parameter of **Hb**.
- There are two types of the current transformers (CT) are available: CTL-6-SF type for 1 A to 30 A and CTL-12-S36-8F type for 20 A to 50 A. Select the suitable type according to the current value of the heater you use.
- How to set the point at which the alarm is activated:
 - Set the output of the PXR to ON continuously to provide the current to the heater.
 - You can monitor the current value of the heater in the parameter of **CF**. Set the value that is 70 to 80 % of the monitored current value as the final set value.
 - When the number of heaters is "n" (more than two), set the middle value between the current of "n" heaters and the current of ("n"-1) heaters.
- When the thyristor (SCR) phase control system is used to control the heater, the parameters of **CF** and **Hb** cannot be used.
- In case detection of an error becomes difficult due to insufficient heater capacity, pass the wire through the CT twice to double the apparent current. This will improve the sensitivity of the CT. (In this case, set the value that is twice as much as the original value.)
- When winding the wire around the CT several times, be sure to wind in the same direction.

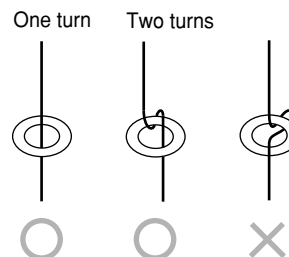

[Note]

For the alarm for heater break, set the proportional cycle (**FL**) to 20 seconds or more.

Related parameter: **FL** (page 31)



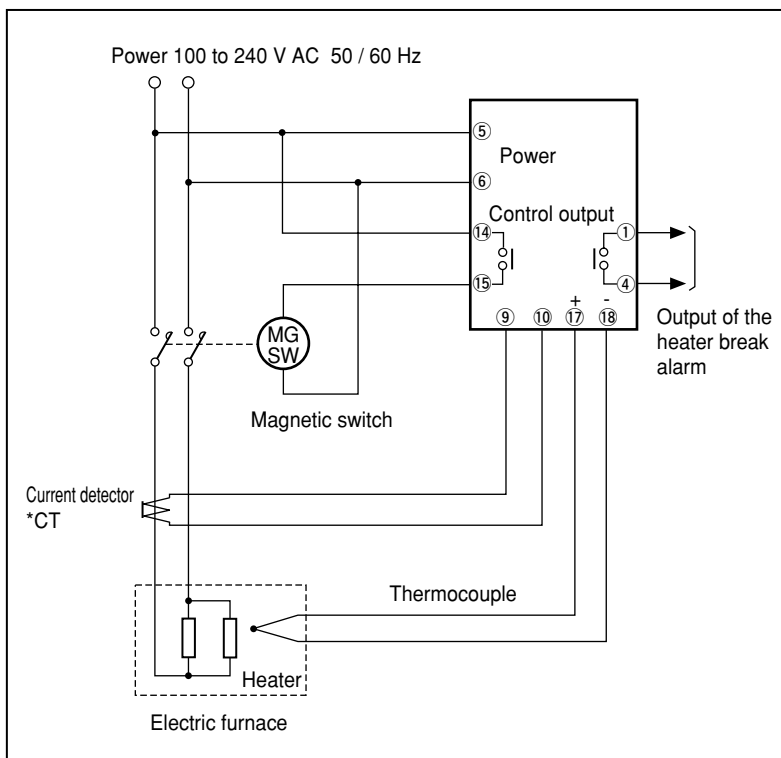



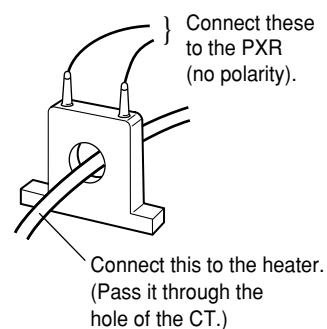



• Connection example for the alarm for heater break (PXR model)



• How to connect the current transformer (CT) for heater break:



[Setting example] Changing the detecting current of heater break from 8.0 A to 9.0A

Display	Operating procedure
	<p>1. Press and hold the SEL key for five seconds.</p>
	<p><i>P-n I</i> will be displayed on the PV display.</p>
	<p>2. Press the  key to display <i>Hb</i>.</p>
	<p>3. Press the SEL key once.</p> <p>The current setting (<i>80</i>) flashes on the SV display.</p>
	<p>4. Press the  or  keys to display <i>90</i>.</p>
	<p>5. Press the SEL key once. <i>90</i> will stop flashing and will be registered for <i>Hb</i>. After that, the controller will operate with detecting current of heater break being 9.0A</p>
	<p>6. If you want to display the operation status, press and hold the SEL key for two seconds.</p>

A1hy , **A2hy** Hysteresis of alarm 1 and 2 (Setting range: 0 to 50% FS) (Option)

[Description]

- The alarm is detected in the two-position operation (ON/OFF). The hysteresis means the difference between the input at ON and the input at OFF. For example, the hysteresis of 5°C means that the range between ON and OFF is 5°C.
- As to the decimal point position, the setting at **P-nP** is respected.
- Hysteresis can be set for each alarm.

- Upper limit alarm

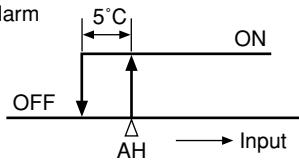

- Lower limit alarm

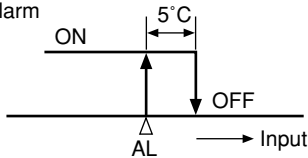

- Range alarm

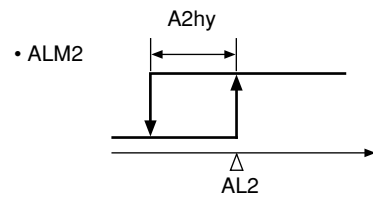
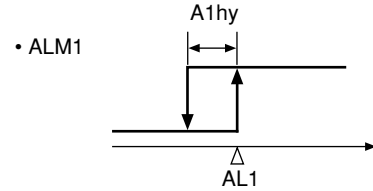

[Setting example] Changing the hysteresis of alarm 2 from 1°C to 3°C

Display	Operating procedure
 	<p>1. Press and hold the SEL key for five seconds. P-nP will be displayed on the PV display.</p>
	<p>2. Press the ▽ key to display A2hy.</p>
	<p>3. Press the SEL key once. The current setting (1) flashes on the SV display.</p>
	<p>4. Press the △ or ▽ keys to display 3.</p>
	<p>5. Press the SEL key once. 3 will stop flashing and will be registered for A2hy. After that, the controller will operate with the hysteresis of alarm 2 being 3°C.</p>
	<p>6. If you want to display the operation status, press and hold the SEL key for two seconds.</p>

A1oP, A2oP Options of alarm 1 and 2 (Setting range: 000 to 111) (Option)

[Description]

- These parameters are used for switch ON/OFF of the alarm latch, the error status alarm, and the de-energized output alarm functions for each of Alarm 1 and 2.
- Each function is set to ON by setting the following digit to "1":

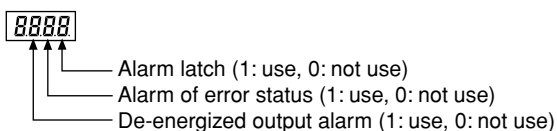

- The alarm latch is the function to keep the alarm ON, once the alarm judgment shows the alarm ON status. To cancel the alarm latch, follow on the following instructions.
 - Power off the PXR, and then on.
 - Set the alarm latch to OFF.
 - Cancel the alarm latch at the alarm latch canceling parameter.
 - Cancel the alarm latch by DI input.
 - Cancel the alarm latch via communication.
- The alarm of error status is activated, when the problems in the table below occur. When using this error status alarm function, set the alarm types (ALM1 or 2) to "0".

Display	Causes
UUUU	<ul style="list-style-type: none"> • A break in the thermocouple sensor • A break in the resistance bulb sensor (RTD) (A) • The PV reading value exceeds the P-SU by 5%FS or more.
LLLL	<ul style="list-style-type: none"> • A break in the resistance bulb sensor (B) or (C) • The resistance bulb sensor (A-B) or (A-C) is short-circuited. • The PV reading value is below the P-SL by 5%FS or more. • A break or a short-circuit in the voltage input line.
FALF	<ul style="list-style-type: none"> • Breakdown in the PXR



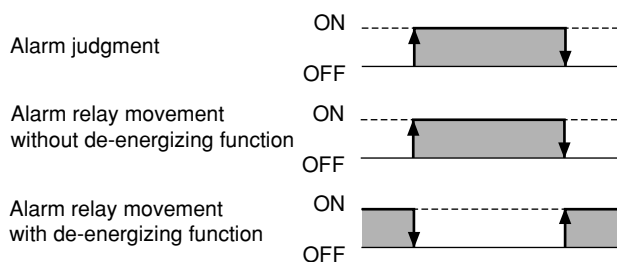







- The de-energized output alarm function is used for energizing or de-energizing the alarm relay to be closed. While this function is set to ON, when the alarm judgment shows the ON status, the relay is opened, and when the alarm judgment shows the OFF status, the relay is closed.



[Note]

- The ON-delay, the alarm latch, and the de-energized output functions can be activated for the error status alarm.
- The alarm lamps (AL1, AL2) goes on and off according to the alarm judgment regardless of the de-energized output settings.

[Setting example] Setting the error status alarm function for Alarm 2 to ON

Display	Operating procedure
	<p>1. Press and hold the SEL key for five seconds.</p>
	<p><i>P-n l</i> will be displayed on the PV display.</p>
	<p>2. Press the  key to display <i>R2oP</i>.</p>
	<p>3. Press the SEL key once.</p> <p>The current setting (<i>000</i>) flashes on the SV display.</p>
	<p>4. Press the  or  keys to display <i>0 10</i>.</p>
	<p>5. Press the SEL key once. <i>0 10</i> will stop flashing and will be registered for <i>R2oP</i>. After that, the controller will operate with the error status alarm function for Alarm 2 being ON.</p>
	<p>6. If you want to display the operation status, press and hold the SEL key for two seconds.</p>

PLC1 , **PHC1** Upper and lower limits for control output 1 (Setting range: -3.0 to 103.0%)

PLC2 , **PHC2** Upper and lower limits for control output 2 (Setting range: -3.0 to 103.0%) (Option)

[Description]

- These parameters set the limit value of output.

	Upper limit	Lower limit
OUT1	PHC1	PLC1
OUT2	PHC2	PLC2

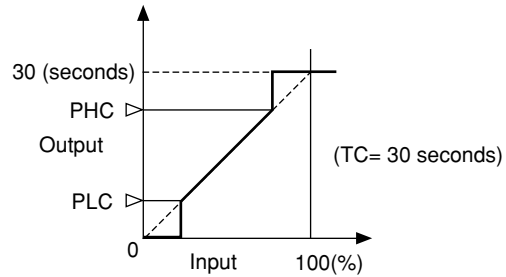

- How the output is limited (maintained within the limit or breaks the limit) is set in the parameter of **PCUF** .
- When flammability is controlled by turning the gas on and off, this function can avoid flashing.

Related parameters: **FC** (page 32)
PCUF (page 57)

$$(\text{Minimum ON pulse width [seconds]}) = \text{PLC1} \times \frac{100}{\text{TC}}$$

$$(\text{Minimum OFF pulse width [seconds]}) = (100 - \text{PHC1}) \times \frac{100}{\text{TC}}$$

FC : Cycle time

[Setting example] Changing the lower pulse width limit from 20.0% to 10.0%

Display	Operating procedure
 	<p>1. Press and hold the SEL key for five seconds. <i>P-n 1</i> will be displayed on the PV display.</p>
	<p>2. Press the key to display PLC1 .</p>
	<p>3. Press the SEL key once. The current setting (<i>200</i>) flashes on the SV display.</p>
	<p>4. Press the or keys to display <i>100</i> .</p>
	<p>5. Press the SEL key once. <i>100</i> will stop flashing and will be registered for PLC1 . After that, the controller will operate with the output lower limit being 10%.</p>
	<p>6. If you want to display the operation status, press and hold the SEL key for two seconds.</p>

PCUR Output limit types (Setting range: 0 to 15)

[Description]

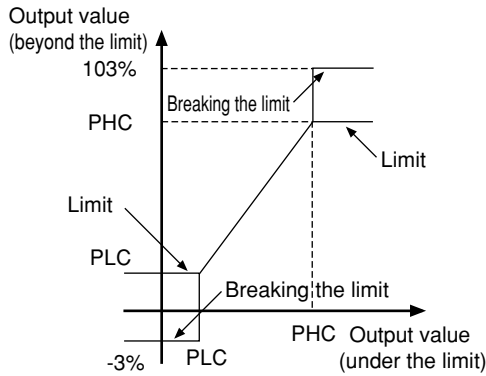

- This parameter sets whether or not to maintain the value within the limit when the output value increases up to the limit set value.



PCUT	Output 1		Output 2	
	Upper limit	Lower limit	Upper limit	Lower limit
0	103%	-3%	103%	-3%
1	103%	Limit	103%	-3%
2	Limit	-3%	103%	-3%
3	Limit	Limit	103%	-3%
4	103%	-3%	103%	Limit
5	103%	Limit	103%	Limit
6	Limit	-3%	103%	Limit
7	Limit	Limit	103%	Limit
8	103%	-3%	Limit	-3%
9	103%	Limit	Limit	-3%
10	Limit	-3%	Limit	-3%
11	Limit	Limit	Limit	-3%
12	103%	-3%	Limit	Limit
13	103%	Limit	Limit	Limit
14	Limit	-3%	Limit	Limit
15	Limit	Limit	Limit	Limit

[Setting example] Selecting the operation that outputs 1 and 2 are maintained within the upper and lower limits







Display	Operating procedure
 	<ol style="list-style-type: none"> Press and hold the [SEL] key for five seconds. <i>P-n l</i> will be displayed on the PV display. Press the [V] key to display <i>PCUR</i>. Press the [SEL] key once. The current setting (<i>0</i>) flashes on the SV display. Press the [^] or [v] keys to display <i>15</i>. Press the [SEL] key once. <i>15</i> will stop flashing and will be registered for <i>PCUR</i>. After that, the controller will operate with outputs 1 and 2 maintained within the upper and lower limits. If you want to display the operation status, press and hold the [SEL] key for two seconds.

 ,  Output value display (Display only: -3.0 to 103.0%)

[Description]

- These parameters display the output values of outputs 1 and 2 in the unit of %. (Since the values are calculated with the software, they may have some error comparing to the actual output.)

[Setting example] Confirming the output value (the calculated value) of control output 1











Display	Operating procedure
   	<ol style="list-style-type: none"> 1. Press and hold the  key for five seconds. <i>p-n 1</i> will be displayed on the PV display. 2. Press the  key to display <i>ouf 1</i>. The output value will appear in the SV display. 3. If you want to display the operation status, press and hold the  key for two seconds.

rcj RCJ (Cold junction compensation) (Setting range: ON/OFF)

[Description]

- This parameter sets whether or not to perform the RCJ (Cold junction compensation) for the thermocouple input. Use the factory default setting (ON: performs the RCJ) under normal conditions.
 - ON: Performs the RCJ (Cold junction compensation).
 - OFF: Does not perform the RCJ (Cold junction compensation).
- Set this parameter to OFF under the conditions that the RCJ is not needed, such as when the RCJ is performed outside of the PXR or when the temperature deviations are recorded.

[Setting example] Changing the RCJ (Cold junction compensation) from ON to OFF

Display	Operating procedure
	<ol style="list-style-type: none"> 1. Press and hold the SEL key for five seconds. P-nl will be displayed on the PV display. 2. Press the  key to display rcj. 3. Press the SEL key once. The current setting (on) flashes on the SV display. 4. Press the  or  keys to display off. 5. Press the SEL key once. off will stop flashing and will be registered for rcj. After that, the controller will operate with the RCJ (Cold junction compensation) being OFF. 6. If you want to display the operation status, press and hold the SEL key for two seconds.
	
	
	
	
	
	

Adj0 Adjusting the PV (Measured value) display (0%) (Setting range: -50 to 50% FS)

Adj5 Adjusting the PV (Measured value) display (100%) (Setting range: -50 to 50% FS)

[Description]

- The user-definable functions are independent of the adjustment values of the PXR. Setting the parameters of **Adj0** and **Adj5** to 0 can return to the factory default settings.

1. Prepare the following devices before adjustment by using these parameters.

- DC voltage standard generator
 - 1 to 5V (for voltage input)
 - 0 to 100 mV (for thermocouple input)
- Decade resistance box
 - 100.0 to 400.0 Ω (for resistance bulb input)

2. Set the parameter of **rLU** to OFF.

3. Apply a voltage that is equivalent of 0%.

If there is an error large enough to impair its accuracy, set the parameter of **Adj0**. (See the right example to set **Adj0**.)

4. Apply a voltage that is equivalent of 100%.

If there is an error large enough to impair its accuracy, set the parameter of **Adj5**. (See the right example to set **Adj5**.)

5. Return the parameter of **rLU** to ON.

[Operating example for input range of 0°C to 400°C]

{ Reading at input of 0°C: -1°C
 { Reading at input of 400°C: 402°C

Set the parameter of **Adj0** to "1".

Set the parameter of **Adj5** to "-2".

Therefore;











{ Reading at input of 0°C: 0°C
 { Reading at input of 400°C: 400°C

[Adjustment example for input range of 0 to 400°C]

Before adjustment	Adjustment value	After adjustment
Display at input of 0°C: -1°C	Adj0 : 1	Display at input of 0°C: 0°C
Display at input of 400°C: 402°C	Adj5 : -2	Display at input of 400°C: 400°C

Setting the parameters of **Adj0** and **Adj5** to "0" returns to the factory default settings.

[Setting example] Setting the zero adjustment to "+1°C"

Display	Operating procedure
      	<p>1. Press and hold the SEL key for five seconds. P-n l will be displayed on the PV display.</p> <p>2. Press the  key to display Adj0.</p> <p>3. Press the SEL key once. The current setting (0) flashes on the SV display.</p> <p>4. Press the  or  keys to display 1.</p> <p>5. Press the SEL key once. 1 will stop flashing and will be registered for Adj0. After that, the controller will operate with the zero adjustment being +1°C.</p> <p>6. If you want to display the operation status, press and hold the SEL key for two seconds.</p>

dl-1 DI1 (Digital input 1) operation (Setting range: 0 to 12)

[Description]

- This parameter (DI1 setting parameter) selects DI functions. Set the DI1 to ON to activate the functions.

Setting range: 0 to 12

- 0 = No function
- 1 = Switches the SV.
- 2 = Control RUN/Standby
- 3 = Starts the auto tuning (standard).
- 4 = Starts the auto tuning (low PV).
- 5 = Cancels latching for all alarms.
- 6 = Cancels latching for alarm 1.
- 7 = Cancels latching for alarm 2.
- 9 = Activates ALM 1 relay timer.
- 10 = Activates ALM 2 relay timer.
- 12 = Ramp-soak operation RUN/RESET

Switching the SV (DI function 1)

- This function switches the SV.

DI1 function	DI1 OFF	DI1 ON
Switching the SV	SV set by front operation (SV 0)	SV 1

- SV-1 of the ramp-soak target SV is used to set the SV 1.
- The SV cannot be changed on the SV display screen while SV-1 is selected.
- While switching the SV, the SV and the SV No. appear alternately. (SV: 2 seconds, SV No.: 1 second) However, the SV No. is not displayed during the ramp-soak operation.

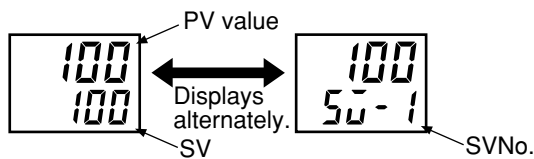

Switching control RUN/Standby (DI function 2)

- RUN and Standby mode is switched by DI1
 - DI ON : Standby
 - DI OFF: RUN
- The SV flashes on standby mode.



← The SV flashes on standby mode.

- The control can also be switched between RUN/Standby manually.

Select ON or OFF in the parameter for **SBY** (Setting standby).

SBY setting screen (the first block)

Display during OFF: RUN mode Display during ON: Standby mode

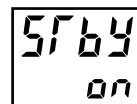
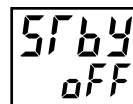

- The table below shows the relationship between the RUN and Standby mode switched with a manual operation, DI 1, and ramp-soak operation.

DI 1	Standby status of ramp-soak operation			
	OFF		ON	
	Manual setting			
	OFF	ON	OFF	ON
DI OFF	RUN	Standby	Standby	Standby
DI ON	Standby	Standby	Standby	Standby

Starting the auto-tuning (DI functions 3, 4)

- These functions set the start/stop of the auto-tuning.

DI function	DI ON edge	DI OFF edge
AT (Standard)	AT start	AT cancel
AT (Low PV)		

Cancel the alarm latch (DI functions 5 to 7)

- These functions can cancel the alarm latch while alarms are latched by setting the alarm latch function to ON.

Set value of d_{L-i}	DI1 ON	DI1 OFF
5	Cancels the latching for alarms 1 and 2	Keeps the alarm latching
6	Cancels the latching for alarm 1	
7	Cancels the latching for alarm 2	

Timer operation (DI functions 9, 10)

- The DI can set the ON/OFF of timer while codes 32 to 34 are set in "Setting alarm types" (page 40). For the operation, see page 40.

Ramp-soak operation RUN/RESET (DI function 12)

- The ramp-soak operation is switched between RUN/RESET by DI1.

DI ON edge \uparrow : RUN

DI OFF edge \downarrow : RESET

[Note]







RUN and RESET are switched by ON and OFF edge of DI.

- The ramp-soak operation can be also switched between RUN/RESET manually.
- The ramp-soak execute types that are set in the parameter of Pf_n operate.
- The table below shows the operations when the DI changes during ramp-soak operation.

Ramp-soak operation status	DI	
	ON edge	OFF edge
RUN	No change	RESET
RESET	RUN	No change
HOLD	RUN	RESET
END	No change	RESET

- When the settings are set manually, via communication, and DI, the settings that are set later are valid.

[Setting example] Changing the SV (SV0) to SV1

Display	Operating procedure
	<p>1. Press and hold the [SEL] key for five seconds. <i>P-n I</i> will be displayed on the PV display.</p>
	
	<p>2. Press the [V] key to display <i>dL- I</i>.</p>
	<p>3. Press the [SEL] key once. The current setting (<i>0</i>) flashes on the SV display.</p>
	<p>4. Press the [^] or [V] keys to display <i>I</i>.</p>
	<p>5. Press the [SEL] key once. <i>I</i> will stop flashing and will be registered for <i>dL- I</i>.</p>
	<p>6. Short-circuit the Di1 terminals. The SV will be changed from SV0 to SV1.</p>
	<p>7. If you want to display the operation status, press and hold the [SEL] key for two seconds. The SV value and SV No. will appear alternately.</p>













Station No. for communication (Setting range: 0 to 255)

[Description]

- Do not set the same number as the set one in other Micro-controllers.
- See Communication function instruction manual for details.

[Setting example] Setting the station No. to "123"

Display	Operating procedure
	<p>1. Press and hold the SEL key for five seconds. <i>P-n!</i> will be displayed on the PV display.</p>
	
	<p>2. Press the  key to display <i>SEL</i>.</p>
	<p>3. Press the SEL key once. The current setting (<i>!</i>) flashes on the SV display.</p>
	<p>4. Press the  or  keys to display <i>123</i>.</p>
	
	<p>5. Press the SEL key once. <i>123</i> will stop flashing and will be registered for <i>SEL</i>. After that, the controller will operate with the station number being 123.</p>
	<p>6. If you want to display the operation status, press and hold the SEL key for two seconds.</p>

[00] Parity for communication (Setting range: 0 to 2)











[Description]

- This parameter sets the parity for communications.

The baud rate is fixed at 9600bps.

- 0 : Odd parity
- 1 : Even parity
- 2 : No parity

[Setting example] Setting the even parity

Display	Operating procedure
 	<p>1. Press and hold the [SEL] key for five seconds. <i>P-n 1</i> will be displayed on the PV display.</p>
	<p>2. Press the  key to display [00].</p>
	<p>3. Press the [SEL] key once. The current setting (<i>0</i>) flashes on the SV display.</p>
	<p>4. Press the  or  keys to display <i>1</i>.</p>
	<p>5. Press the [SEL] key once. <i>1</i> will stop flashing and will be registered for [00]. However, it does not switch to the even parity at this point.</p>
	<p>6. Power off the PXR, and then on. The even parity is set now.</p>

PYP











Input type for PYP (Color Touch-Operation Unit) (Setting range: 0 to 7, 32 to 47)

[Description]

- When the Color Touch-Operation Unit (Model: PYP) made by Fuji Electric is connected to the PXR, this parameter makes the PYP recognize the measured range.
- When setting the same temperature range that is set in the input range, P-SL, and P-SU of the PXR, the readings between the PXR and PYP are met.

Set value	Input type		Temperature range(°C)
00	Resistance bulb	Pt100	0 to 150°C
01	JIS		0 to 300°C
02	IEC		0 to 500°C
03			0 to 600°C
04			-50 to 100°C
05			-100 to 200°C
06			-150 to 600°C
07			-150 to 850°C
32	Thermocouple	J	0 to 400°C
33		J	0 to 800°C
34		K	0 to 400°C
35		K	0 to 800°C
36		K	0 to 1200°C
37		R	0 to 1600°C
38		B	0 to 1800°C
39		T	-199.9 to 200°C
40		T	-150 to 400°C
41		E	0 to 800°C
42		E	-199.9 to 800°C
43		S	0 to 1600°C
44		N	0 to 1300°C
45		U	-199.9 to 400°C
46		WRe5 · 26	0 to 2300°C
47		PLII	0 to 1300°C

[Setting example] Setting the input range of the PXR to thermocouple B

Display	Operating procedure
      	<ol style="list-style-type: none"> 1. Press and hold the [SEL] key for five seconds. P-n I will be displayed on the PV display. 2. Press the  key to display PYP. 3. Press the [SEL] key once. The current setting (34) flashes on the SV display. 4. Press the  or  keys to display 38. 5. Press the [SEL] key once. 38 (Thermocouple B) will stop flashing and will be registered for PYP. After that, PYP will recognize the input range of the PXR as thermocouple B (0 to 1800°C). 6. If you want to display the operation status, press and hold the [SEL] key for two seconds.

dSP 1 to **dSP 9**

dP 10 to **dP 13**











Parameter display mask (Setting range: 0 to 255)

[Description]

- This parameter skips the parameter display by items.
- This parameter is used not to display the items that are not used, or not to change the settings mistakenly.
- "Parameter mask DSP" in "2-1 Parameter list" (pages 5 to 7) shows which parameter is skipped by setting **dSP 1** to **dSP 9** and **dP 10** to **dP 13**.
- Set the total value of the item codes that you want to skip.

[Setting example] Skipping "l" and "d"

Setting "4+8=12" according to the code table of dSP3

Display	Operating procedure
	<ol style="list-style-type: none">1. Press and hold the SEL key for five seconds. P-n l will be displayed on the PV display.2. Press the  key to display dSP 3.3. Press the SEL key once. The current setting (0) flashes on the SV display.4. Press the  or  keys to display 12.5. Press the SEL key once. 12 will stop flashing and will be registered for dSP 3. After that, the parameters of l and d will be skipped, and will not be displayed.6. If you want to display the operation status, press and hold the SEL key for two seconds.
	
	
	
	
	
	

3 Troubleshooting

This section explains the judgments and remedies for problems.

Symptoms	Possible causes	Remedies	Reference pages
1. The display has shown UUUU or LLLL .	① The setting of P-n2 is not correct for the input signals of sensors or others.	Set the parameter of P-n2 correctly.	Page 33
	② The polarity of the sensor does not match that of the PXR.	Correct the polarity of the sensor and the PXR.	Page 51
	③ Input terminals are short-circuited in thermocouple B or R. (P-n2 = 4, 5)	Set the parameter of P-n2 to 3, and check if the temperature around an ordinary temperature is displayed. (Thermocouples B and R have a large error around ordinary temperatures. However, this is not a fault.)	Page 33
	④ The input signals of sensors or others do not match those of the controller you use.	Ask to make adaptations on your model. Or replace your model with a new one.	-
	⑤ The connecting cables for the sensor are loose.	Tighten the connecting cables.	-
	⑥ A break or short-circuit occurred in the sensor.	Replace the sensor with a new one. Or remove the short-circuit.	-
	⑦ The sensor or other input devices that are connected to the PXR have problems.	Replace the sensor or other input devices with new ones.	-
	⑧ The set value of the parameter of P-SL is larger than the value of P-SU .	Set the parameters again so that the value of P-SL is smaller than the value of P-SU .	Page 34
	⑨ The measured value is too large or too small.	Set the parameters again so that the difference of the set values of P-SL and P-SU is made larger.	Page 34
2. Err has been displayed.	① The value of P-SU is set to 3277°C or more for thermocouple and resistance bulb input.	Set the parameters of P-SL and P-SU again according to the input range table.	Page 34
	② The measured range (P-SU to P-SL) is set to 10000 or more for voltage and current input.	Set the parameters of P-SL and P-SU again so that the measured range is 9999 or less.	Page 34
3. A decimal point has not been displayed.	"0" is set in the parameter of P-dP .	Set the parameter of P-dP to "1" or "2".	Page 36
4. The SV or the set values of some parameters have been changed without any operation.	① The parameter of P-SL , P-SU , or P-dP was changed.	Set all the parameters again. (When the set values of the parameters of P-SL , P-SU , and P-dP are changed, the set value of each parameter for which "*" is marked with the page 5 to 8 of the Parameter list, are changed.)	Page 34 Page 5 to 8
	② When the set value of P-SU is larger than 1000, "1" is registered for P-dP .	Set P-dP to "0", and return P-SU to an original value.	Page 34
5. ON/OFF control (Two-position control) has not started.	0.0 is not set in the parameter of P .	Set the parameter of P to 0.0.	Page 18
6. ON/OFF control has not function properly.	① The set value of parameter HYS is not correct.	Adjust the set value of parameter HYS to be suitable for the device to be controlled.	Page 21
	② The setting of parameter onoF is not correct.	Set the parameter onoF correctly.	Page 30
7. The Micro-controller has not controlled properly.	① The set values of the parameters P , τ , and d are not correct.	Perform the auto-tuning.	Page 14
	② The cycle times are too long.	Decrease the set value of the parameters τC and τC2 gradually.	Page 31
	③ Output is limited.	Set the parameters of PLC1 , PHC1 , PLC2 , and PHC2 again to be suitable for the process.	Page 56
	④ Output is not limited correctly.	Set the parameters of PLUF again to be suitable for the process.	Page 57

Symptoms	Possible causes	Remedies	Reference pages
8. Response is too slow. (The measured value changes slowly.)	Input filter constant is too large.	Decrease the set value of the parameter of $P-dF$.	Page 39
9. Output changes between ON and OFF, but the reading does not change.	① Some input terminals are short-circuited.	Remove the short-circuited terminals.	-
	② The connecting cable for the device to be controlled are not connected properly.	Connect it properly.	-
	③ The device to be controlled has powered off.	Power it on.	-
	④ The output signals of the Micro-controller do not match the input signals of the device to be controlled.	Prepare the Micro-controller to be suitable for the device to be controlled. Or select the device to be controlled to be suitable for the Micro-controller.	-
10. The keys do not operate. The set value of the parameters cannot be changed.	"1", "2", "4", or "5" is set in the parameter of LoC .	Set the parameter of LoC to "0" or "3".	Page 17
11. The SV cannot be changed.	① "1", or "4" is set in the parameter of LoC .	Set the parameter of LoC to "0", "2", "3" or "5".	Page 17
	② You have tried to set the value that is outside of the SV limiter (Parameters of $S\bar{u}-L$ to $S\bar{u}-H$).	Widen the range of $S\bar{u}-L$ to $S\bar{u}-H$. (However, it should be within the set range in the input range table.)	Page 48
	③ You have tried to change the SV during ramp-soak operation (rUn , Hld , or End is selected.)	Set the parameter of $Pr\bar{o}G$ to oFF .	Page 12
12. The parameters you want to confirm or change are not displayed.	The concerned parameters are set to skip in the parameters of $dSP1$ to $dP13$.	Change the set value of the concerned dSP.	Page 67
13. Auto-tuning does not work properly.	① After starting the auto-tuning operation, the display has showed $UUUU$ or $LLLL$.	Set the parameters again so that the difference of the set values of $P-SL$ and $P-SU$ is made larger, and perform the auto-tuning again.	Page 34
	② You have changed the SV after starting the auto-tuning operation.	Set the desirable SV, and perform the auto-tuning again.	-
	③ The response of the controlled device was too fast.	Use a controller whose control cycle is fast, such as PYH.	-
	④ You have tried to perform the auto-tuning during ramp-soak operation.	Set the parameter of $Pr\bar{o}G$ to oFF , and perform the auto-tuning again.	Page 12
	⑤ Peripheral devices have problems. Or they are not connected properly.	Connect them properly.	Page 51
	⑥ Direct/reverse actions are not suitable for the operations of the device to be controlled.	Set the parameter of $P-nI$ properly.	Page 47
	⑦ The response of the controlled device was too slow, and the auto-tuning did not finish in 9 hours.	Perform the tuning manually. (Set the parameter of P to "0" to try the ON/OFF control in a hurry.)	Page 18
14. An excessive overshoot has occurred during auto-tuning operation.	-	(1) Perform the auto-tuning with the parameter of Rf being "2" (Low PV type).	Page 14
	-	(2) Perform the tuning manually.	Page 18
15. The self-tuning does not work properly.	See the section of the parameter of $[Frl]$.		Page 25

Index

A		O	
Adjusting the PV display (0%)	60	ON/OFF control (two-position control)	18
Adjusting the PV display (100%)	60	Operation methods	5
Alarm codes	41	Output direction at input burn-out	47
Alarm types	40	Output limit types	57
Anti-reset windup	24	Output offset value	24
Auto-tuning function	14	Overlap band	23
B		P	
Basic operations	9	Parameter functions and method of settings	10
C		Parameter list	5
Calibrating the input	60	Parity for communication	65
Canceling the alarm latch	13	Part names and functions	4
Cold junction compensation	59	Power-on start	12
Contact output	31	Proportional band	18
Control algorithm	25	PV (Measured value) offset	37
Cooling side proportional band shift	23	R	
Cooling side proportional coefficient	22	Ramp-soak control	12
Current detector input	51	Ramp-soak modes	44
Cycle time of control output 1	31	Ramp-soak status display	44
Cycle time of control output 2 (Cooling-side)	32	Range alarm	53
D		RCJ (Cold junction compensation)	59
Dead band	23	Reverse action	47
Decimal point position	36	S	
De-energized output alarm	54	Selecting ramp-soak excute type	43
Derivative time	20	Selection °C / °F	34
DI1 operation setting	61	Self-tuning	26
Direct action	47	Setting alarm 1 and 2	16
Displaying On-delay alarm or the remaining time of timers	15	Setting alarm 1 and 2	16
Displaying the current input value	51	Setting the measuring range (Input range)	34
Displaying the output value	58	Setting the ramp segment time	44
Dual output	22	Setting the soak segment time	44
E		Specifying control action and output direction at input burn-out ..	47
Error display alarm	54	Standby settings	11
H		Station No. for communication	64
Hb (Set value of heater break alarm)	51	SV (Setting value) lower limiter	48
HYS (Hysteresis) mode at ON/OFF control	30	SV (Setting value) offset	38
Hysteresis alarm 1 and 2	53	SV (Setting value) upper limiter	48
Hysteresis operation	30	Switching the parameters	9
Hysteresis range for ON/OFF control	21	T	
I		The time of ON-delay alarm or timer function	49
Input signal code	33	Time constant of input filter	39
Input type for PYP (Color Touch-Operation Unit)	66	Timer code	41
Integral time	19	Troubleshooting	68
K		U	
Key lock	17	Upper alarm	53
L		Upper and lower limits for control output 1	56
Low PV type	14	User settings	60
Lower limit alarm	53		
Lower limit of alarm 1 and 2	16		



Future Design Controls Warranty

Future Design Controls products are warranted to be free from functional defects in material and workmanship at the time the products leave Future Design Controls facilities and to conform at that time to the specifications set forth in the relevant Future Design Controls manual or data sheets, for a period of TWO years after delivery to the first purchaser for use. An extended period is available for an additional cost upon request.

Future Design Controls sole responsibility under the warranty, at Future Design Controls option, is limited to replacement or repair, free of charge, or refund of purchase price within the warranty period specified. This warranty does not apply to damage resulting from transportation, alteration, misuse or abuse.

Future Design Controls provides no warranty or representations of any sort regarding the fitness of use or application of its products by the purchaser. The selection, applications or use of Future Design Controls products is the purchaser's responsibility. No claims will be allowed for any damages or losses, whether direct, indirect, incidental, special or consequential. In addition, Future Design Controls reserves the right to make changes without notification to purchaser to materials or processing that do not affect compliance with any applicable specifications.