

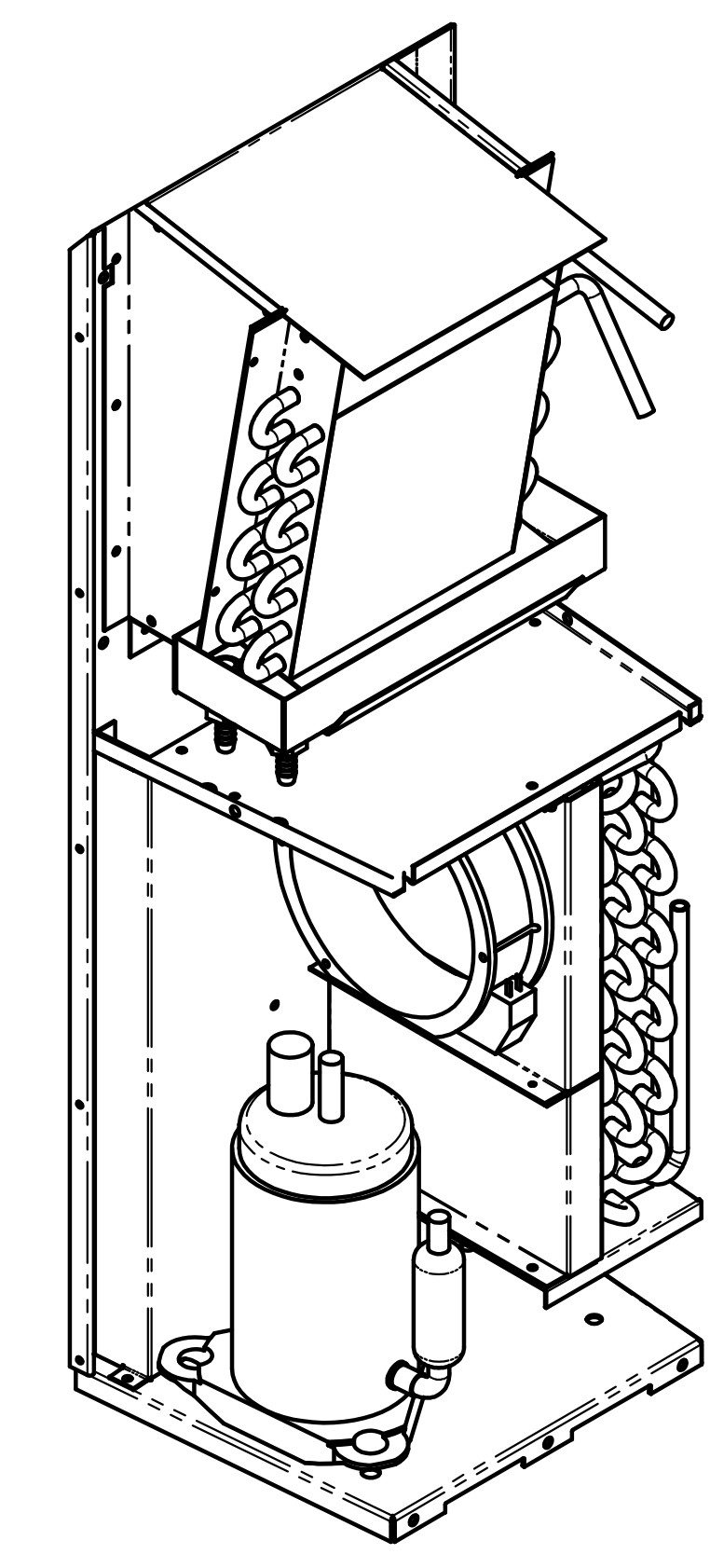

REVISION HISTORY			
REV	DESCRIPTION	DATE	APPROVED

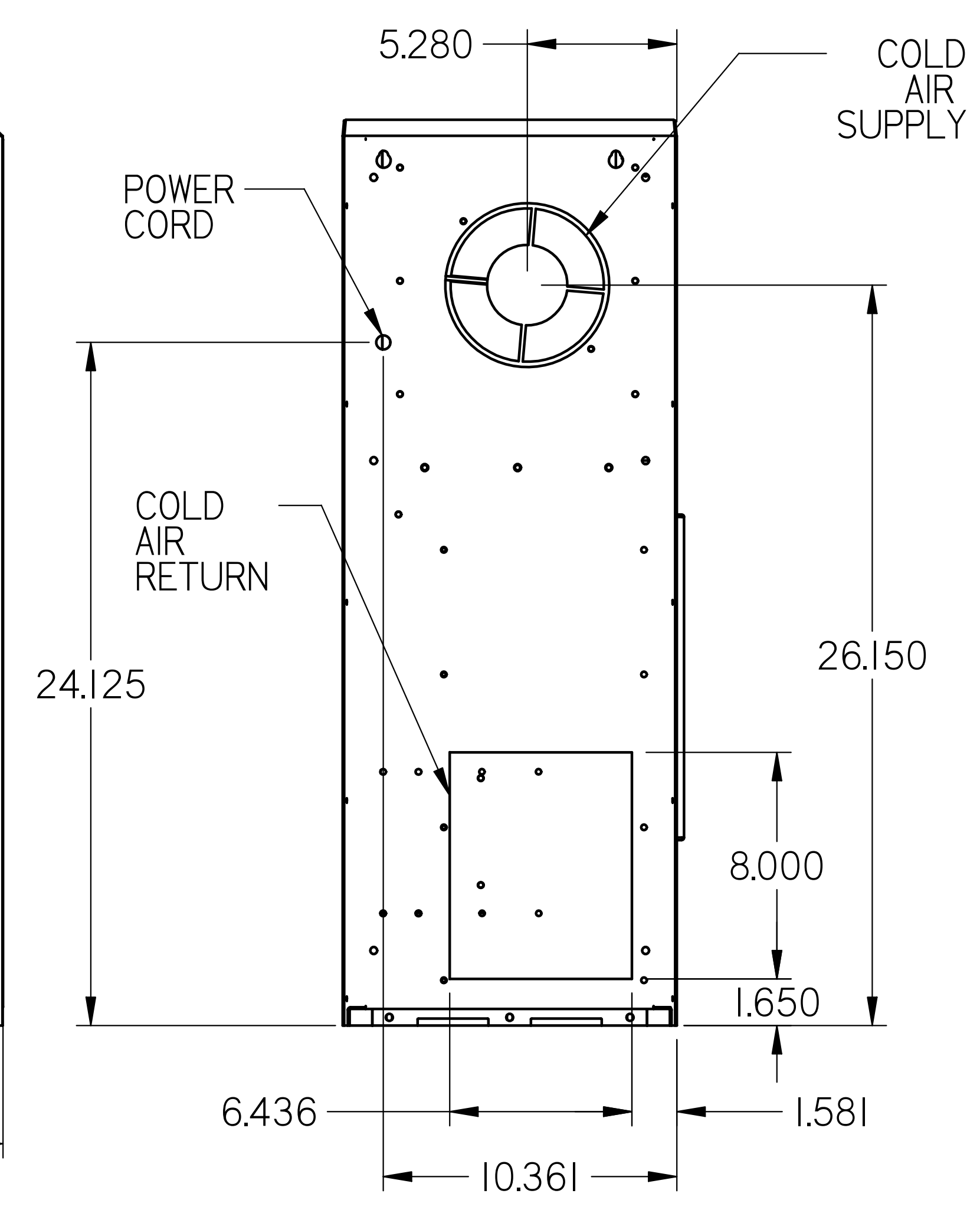
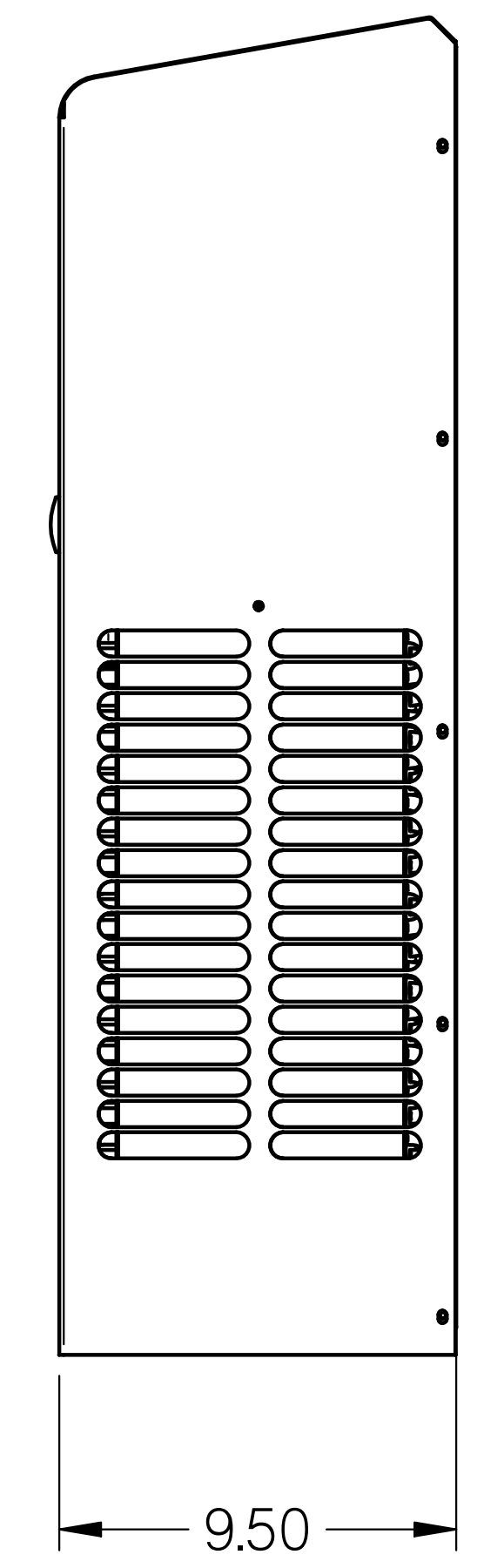
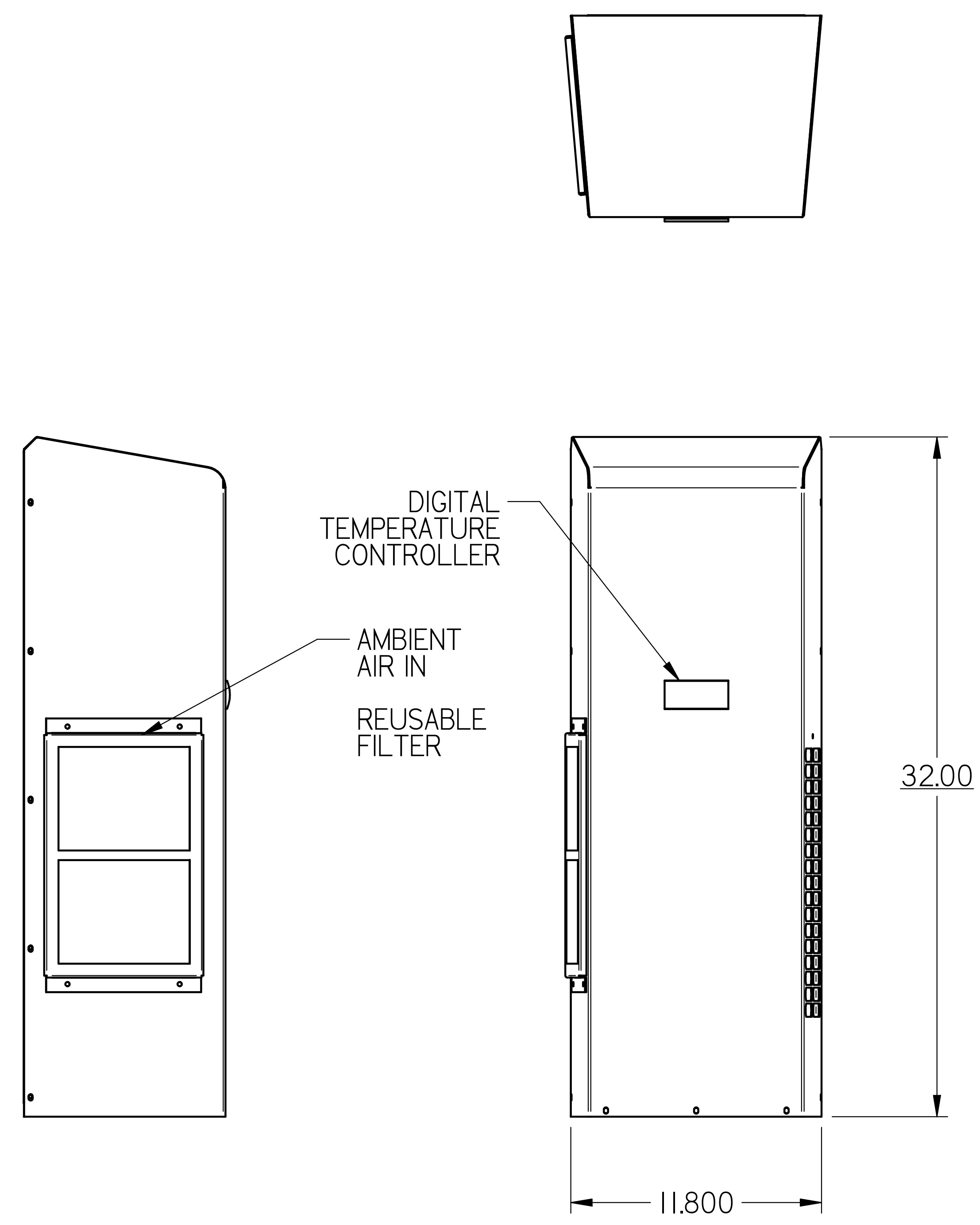

	NAME	DATE	 Thermal Edge Inc. TITLE NE 3000 BTUH
DRAWN	atittle	02/23/07	
CHECKED			
ENG APPR			
MGR APPR			
UNLESS OTHERWISE SPECIFIED DIMENSIONS ARE IN INCHES ANGLES ±1° or 1 PL ±0.5° 2 PL ±0.02 3 PL ±0.010			SIZE DWG NO REV D tei NE3000 FILE NAME: TEI NE 3000.dft SCALE: WEIGHT: SHEET 1 OF 1